

UCT 215 ASAHI

Ball bearing units

TYPE: Housing units, Take-up housing units, Cast iron housing, Radial insert ball bearing with grub screws in inner ring, Type UCT (ASAHI)

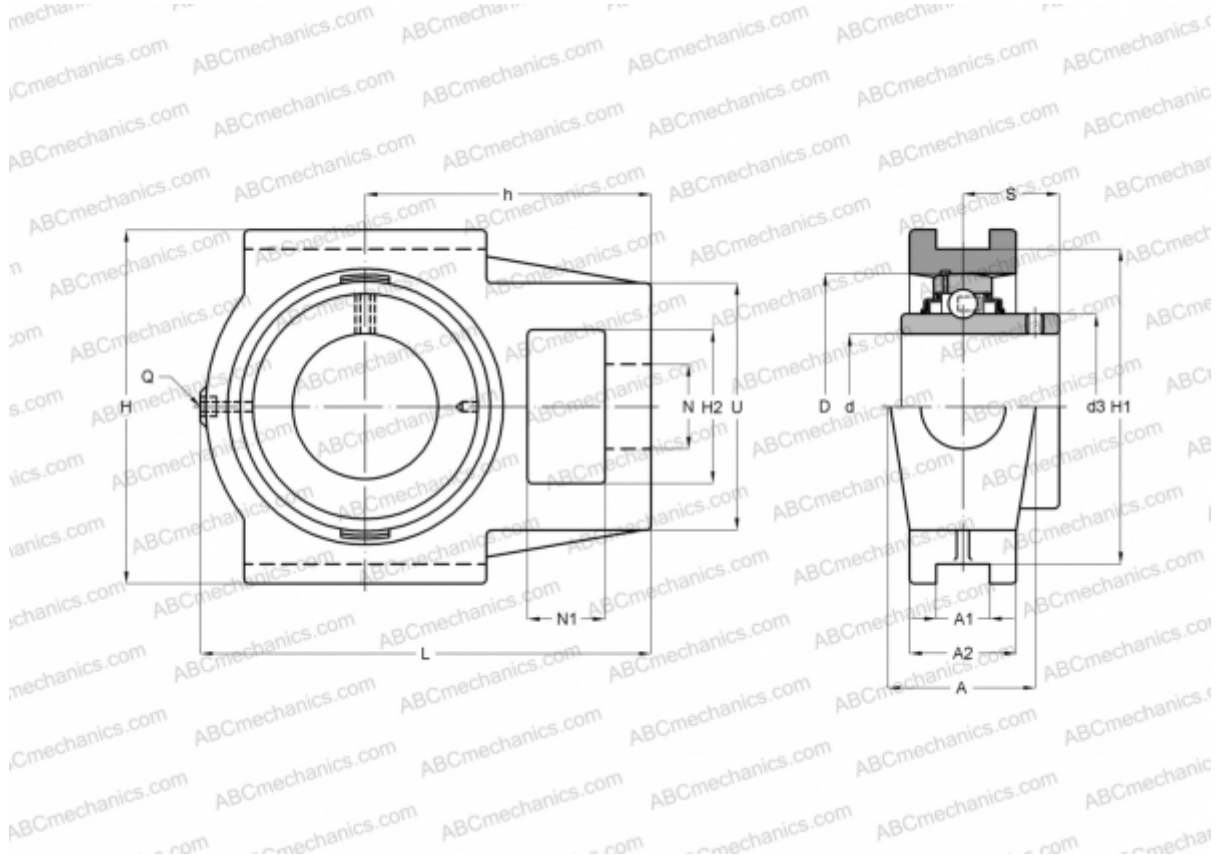

Technical specification

DIMENSIONS, MM

d	75,000
D	130,000
B	77,800
L	232,000
H	167,000
A	70,000
H2	70,000
A1	26,000
A2	48,000
H1	151,000
N	41,000
N1	32,000
S	44,500
d3	91,500
U	111,000

DIMENSIONS, MM

h	140,000
---	---------

WEIGHT, KG

	7,500
Bearing	UC 215
Housing	T 215

MANUFACTURER

[ASAHI](#)