

UCT 216 ASAHI

Ball bearing units

TYPE: Housing units, Take-up housing units, Cast iron housing, Radial insert ball bearing with grub screws in inner ring, Type UCT (ASAHI)

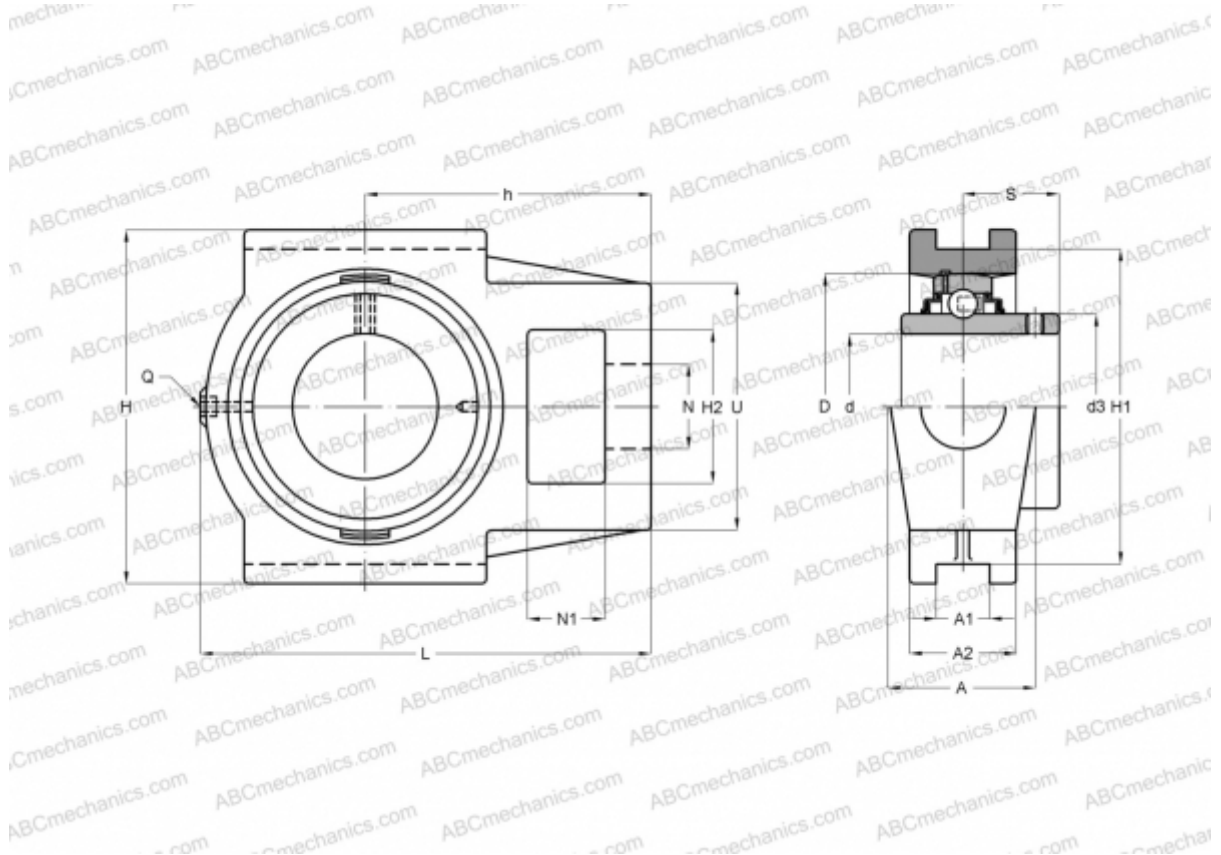

Technical specification

DIMENSIONS, MM

d	80,000
D	140,000
B	82,600
L	235,000
H	184,000
A	70,000
H2	70,000
A1	26,000
A2	51,000
H1	165,000
N	41,000
N1	32,000
S	49,300
d3	98,500
U	111,000

DIMENSIONS, MM

h	140,000
---	---------

WEIGHT, KG

Bearing	UC 216
Housing	T 216

MANUFACTURER

[ASAHI](#)