

## UCT 217 ASAHI

Ball bearing units

TYPE: Housing units, Take-up housing units, Cast iron housing, Radial insert ball bearing with grub screws in inner ring, Type UCT (ASAHI)

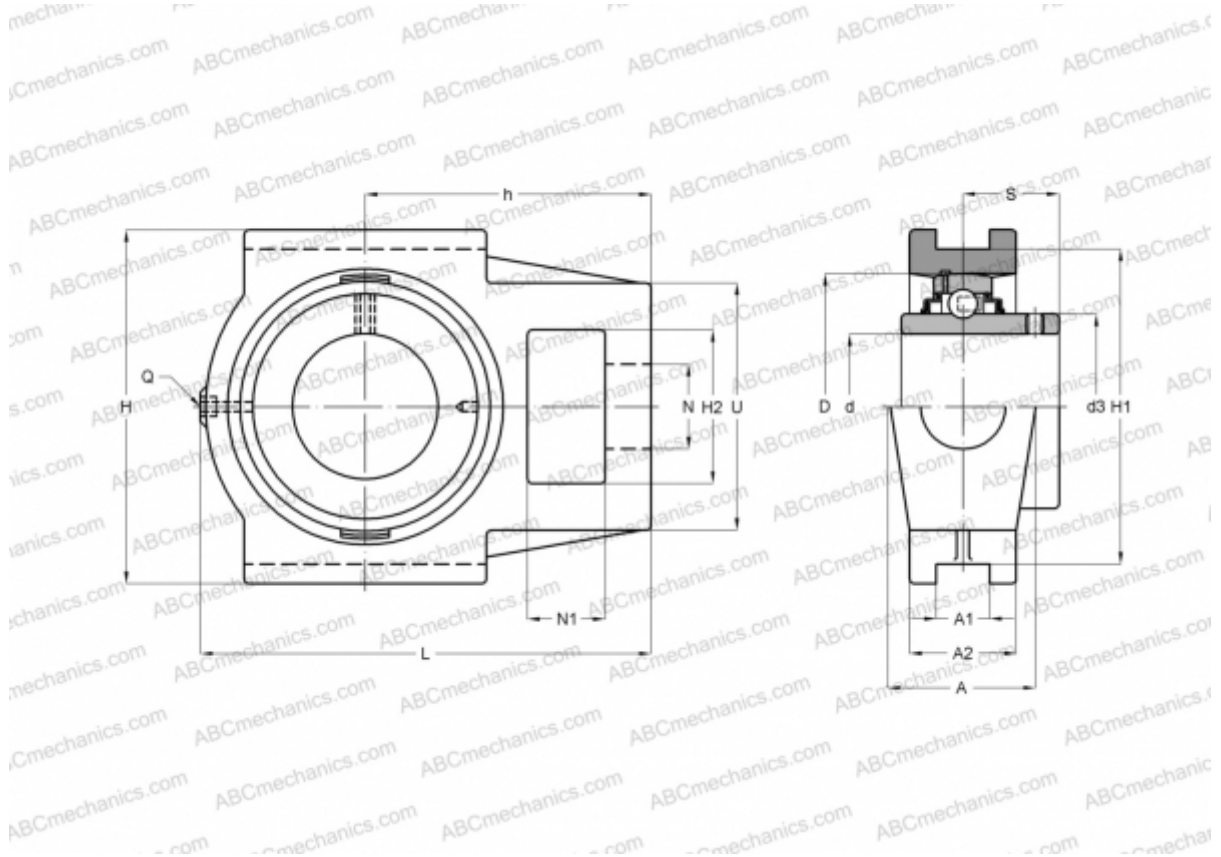

### Technical specification

#### DIMENSIONS, MM

d	85,000
D	150,000
B	85,700
L	260,000
H	198,000
A	73,000
H2	73,000
A1	30,000
A2	54,000
H1	173,000
N	48,000
N1	38,000
S	51,600
d3	105,000
U	124,000

#### DIMENSIONS, MM

h	162,000
---	---------

#### WEIGHT, KG

Bearing	UC 217
Housing	T 217

#### MANUFACTURER

[ASAHI](#)