

UCT 306 ASAHI

Ball bearing units

TYPE: Housing units, Take-up housing units, Cast iron housing, Radial insert ball bearing with grub screws in inner ring, Type UCT (ASAHI)

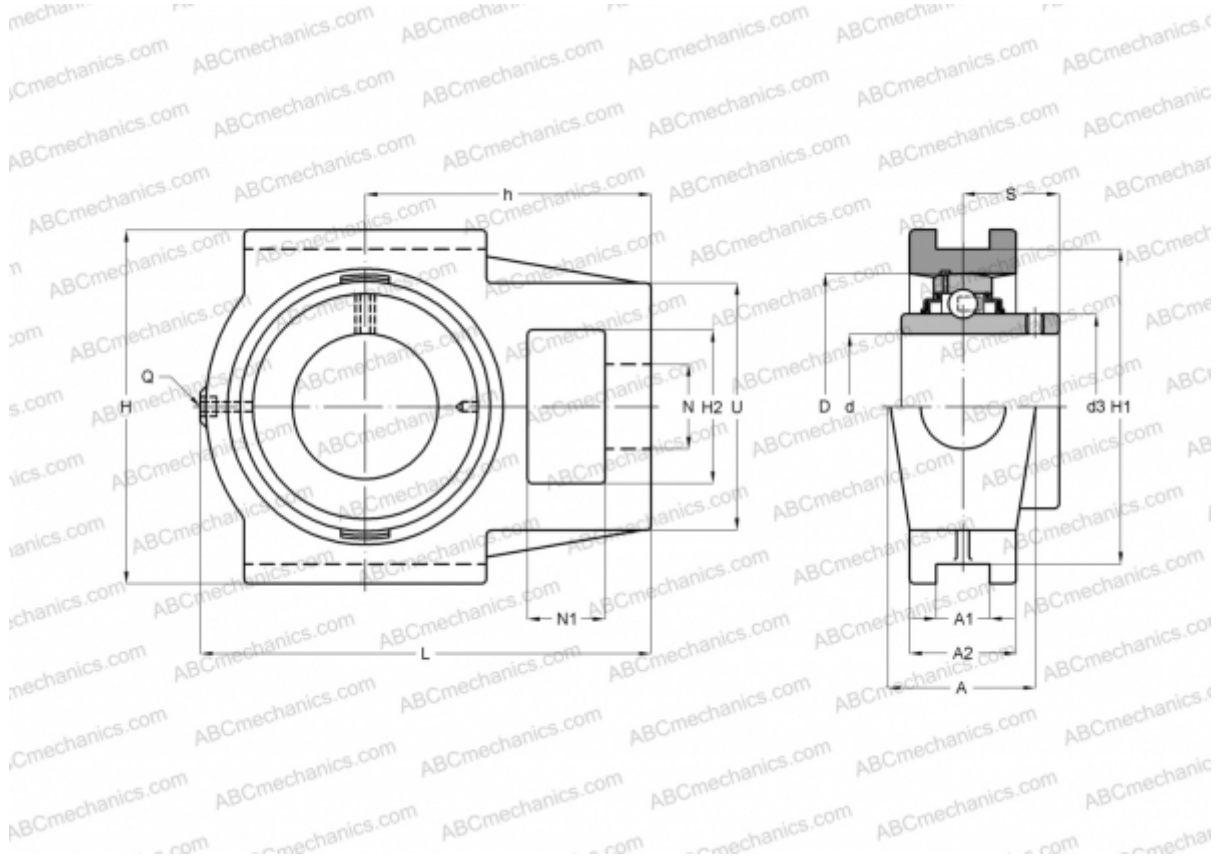

Technical specification

DIMENSIONS, MM

d	30,000
D	72,000
B	43,000
L	137,000
H	100,000
A	41,000
H2	41,000
A1	16,000
A2	28,000
H1	90,000
N	28,000
N1	18,000
S	26,000
d3	45,000
U	70,000

DIMENSIONS, MM

h	85,000
---	--------

WEIGHT, KG

Bearing	UC 306
Housing	T 306

MANUFACTURER

[ASAHI](#)