

## UCT 311 ASAHI

Ball bearing units

TYPE: Housing units, Take-up housing units, Cast iron housing, Radial insert ball bearing with grub screws in inner ring, Type UCT (ASAHI)

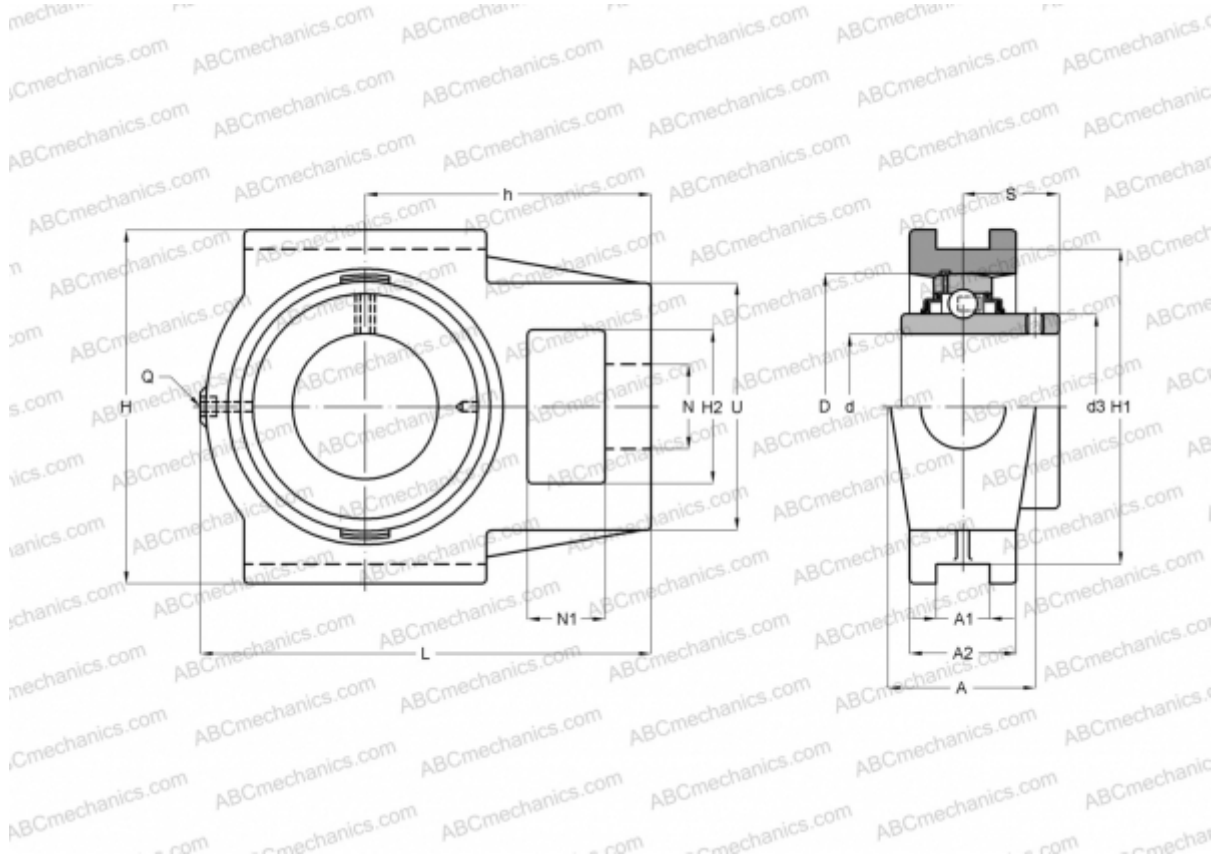

### Technical specification

#### DIMENSIONS, MM

d	55,000
D	120,000
B	66,000
L	207,000
H	163,000
A	66,000
H2	66,000
A1	22,000
A2	44,000
H1	150,000
N	39,000
N1	29,000
S	41,000
d3	76,500
U	105,000

#### DIMENSIONS, MM

h	127,000
---	---------

#### WEIGHT, KG

6,400	
Bearing	UC 311
Housing	T 311

#### MANUFACTURER

[ASAHI](#)