

## UCT 312 ASAHI

Ball bearing units

TYPE: Housing units, Take-up housing units, Cast iron housing, Radial insert ball bearing with grub screws in inner ring, Type UCT (ASAHI)

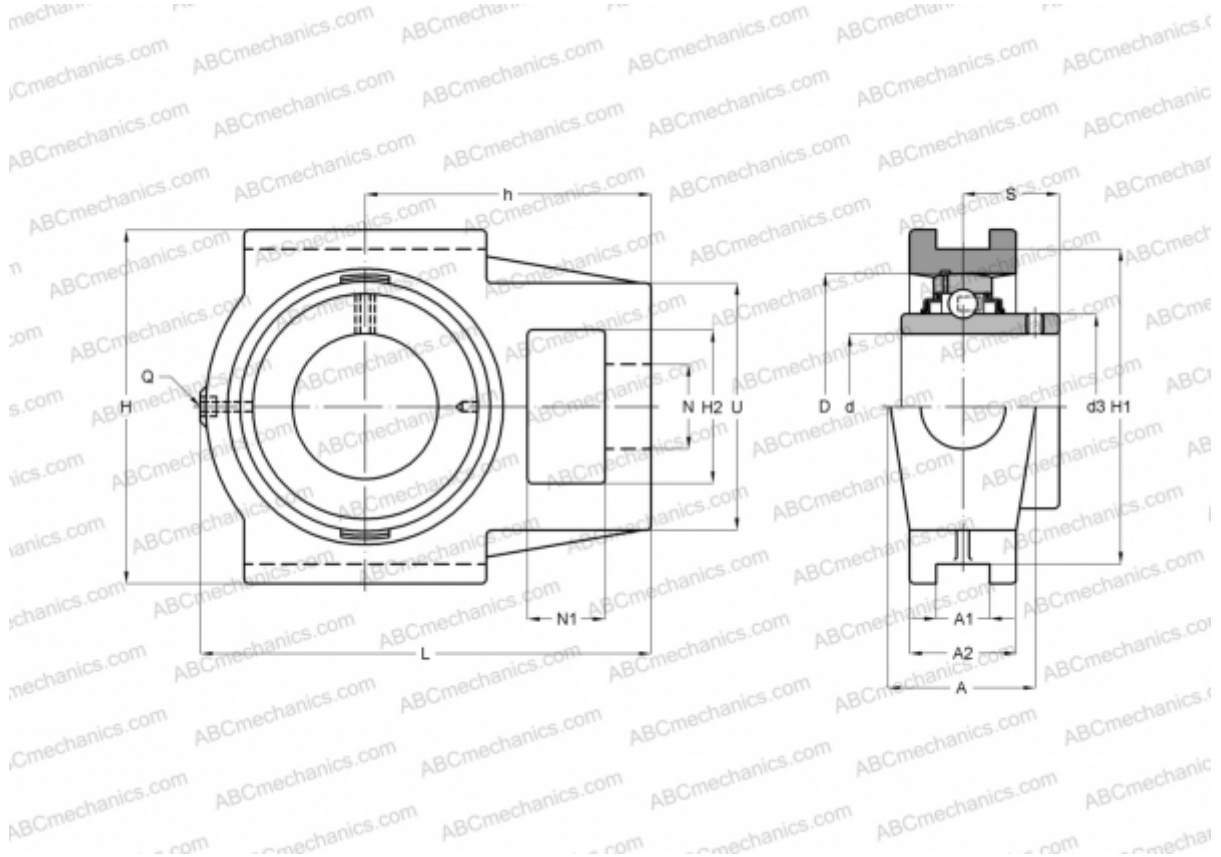

### Technical specification

#### DIMENSIONS, MM

d	60,000
D	130,000
B	71,000
L	220,000
H	178,000
A	71,000
H2	71,000
A1	22,000
A2	46,000
H1	160,000
N	41,000
N1	31,000
S	45,000
d3	82,500
U	113,000

#### DIMENSIONS, MM

h	135,000
---	---------

#### WEIGHT, KG

Bearing	UC 312
Housing	T 312

#### MANUFACTURER

[ASAHI](#)