

UCT 314 ASAHI

Ball bearing units

TYPE: Housing units, Take-up housing units, Cast iron housing, Radial insert ball bearing with grub screws in inner ring, Type UCT (ASAHI)

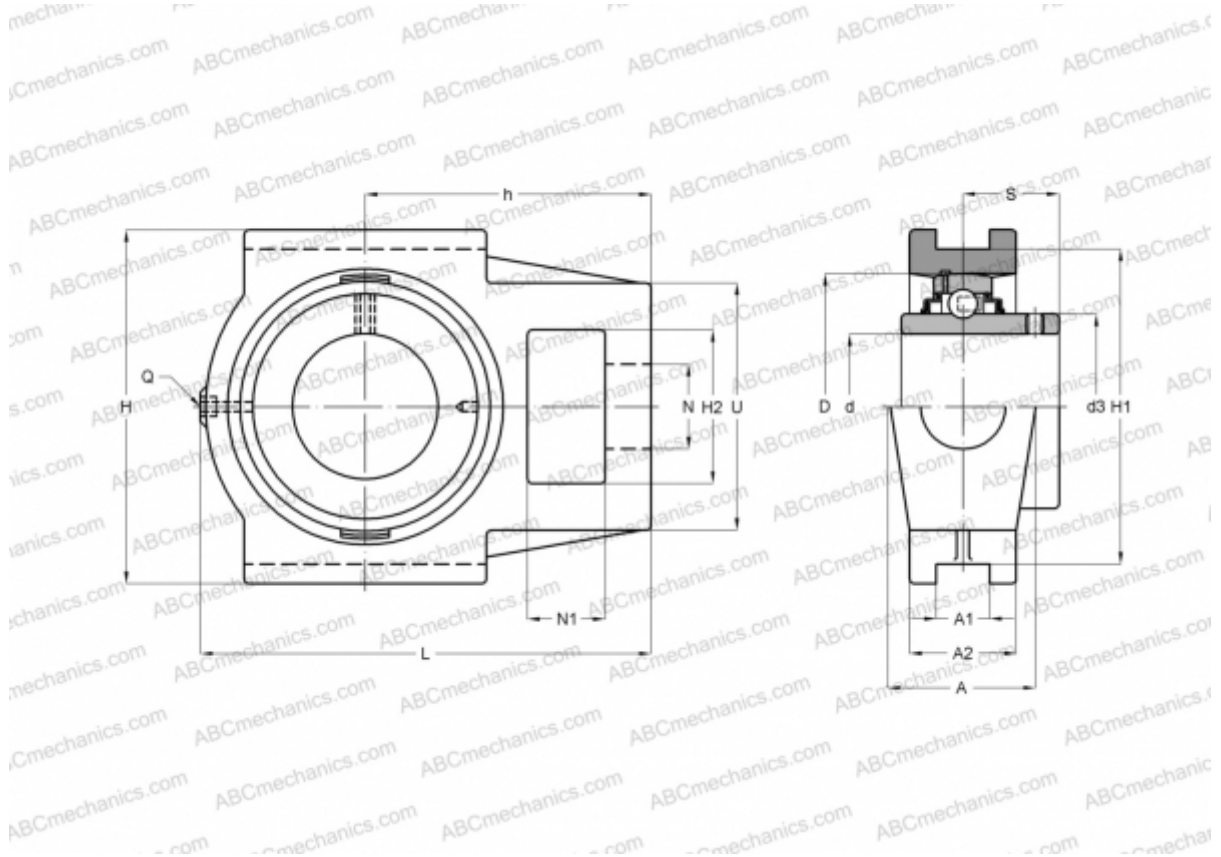

Technical specification

DIMENSIONS, MM

d	70,000
D	150,000
B	78,000
L	252,000
H	202,000
A	90,000
H2	85,000
A1	26,000
A2	52,000
H1	180,000
N	46,000
N1	36,000
S	45,000
d3	95,200
U	130,000

DIMENSIONS, MM

h	155,000
---	---------

WEIGHT, KG

Bearing	UC 314
Housing	T 314

MANUFACTURER

[ASAHI](#)