

UCT 315 ASAHI

Ball bearing units

TYPE: Housing units, Take-up housing units, Cast iron housing, Radial insert ball bearing with grub screws in inner ring, Type UCT (ASAHI)

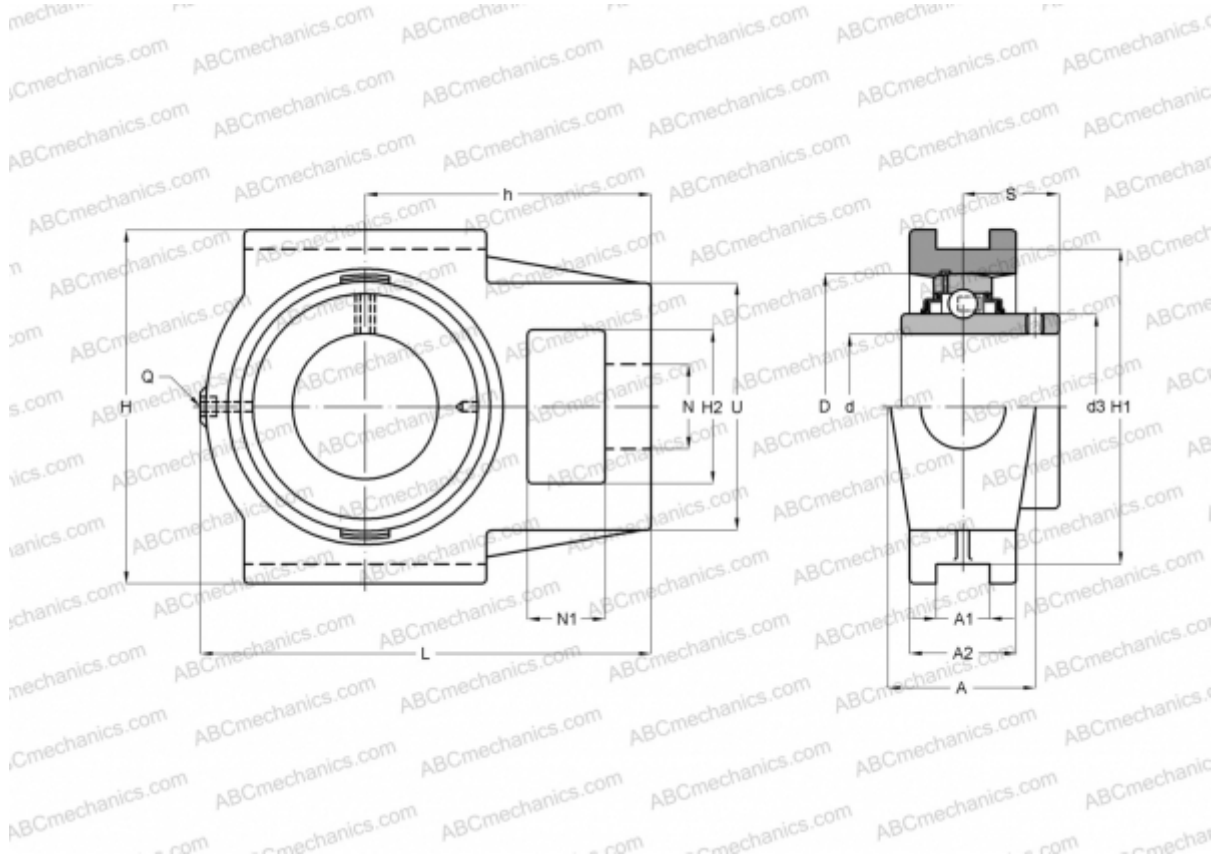

Technical specification

DIMENSIONS, MM

d	75,000
D	160,000
B	82,000
L	262,000
H	216,000
A	90,000
H2	85,000
A1	26,000
A2	55,000
H1	192,000
N	46,000
N1	36,000
S	50,000
d3	101,500
U	132,000

DIMENSIONS, MM

h	160,000
---	---------

WEIGHT, KG

Bearing	UC 315
Housing	T 315

MANUFACTURER

[ASAHI](#)