

UCT 317 ASAHI

Ball bearing units

TYPE: Housing units, Take-up housing units, Cast iron housing, Radial insert ball bearing with grub screws in inner ring, Type UCT (ASAHI)

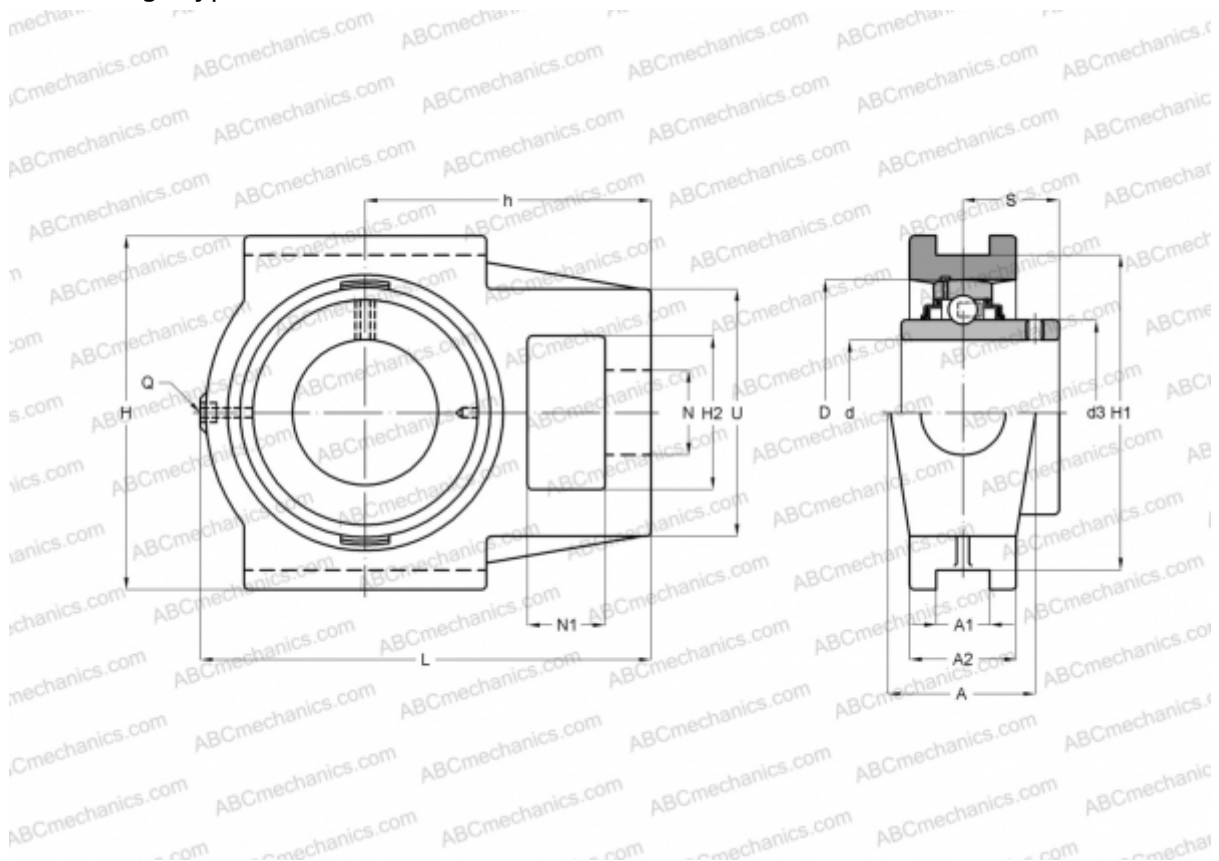

Technical specification

DIMENSIONS, MM

d	85,000
D	180,000
B	96,000
L	298,000
H	240,000
A	102,000
H2	98,000
A1	32,000
A2	64,000
H1	214,000
N	53,000
N1	42,000
S	56,000
d3	114,500
U	152,000

DIMENSIONS, MM

h	183,000
---	---------

WEIGHT, KG

Bearing	UC 317
Housing	T 317

MANUFACTURER

[ASAHI](#)