

UCT 320 ASAHI

Ball bearing units

TYPE: Housing units, Take-up housing units, Cast iron housing, Radial insert ball bearing with grub screws in inner ring, Type UCT (ASAHI)

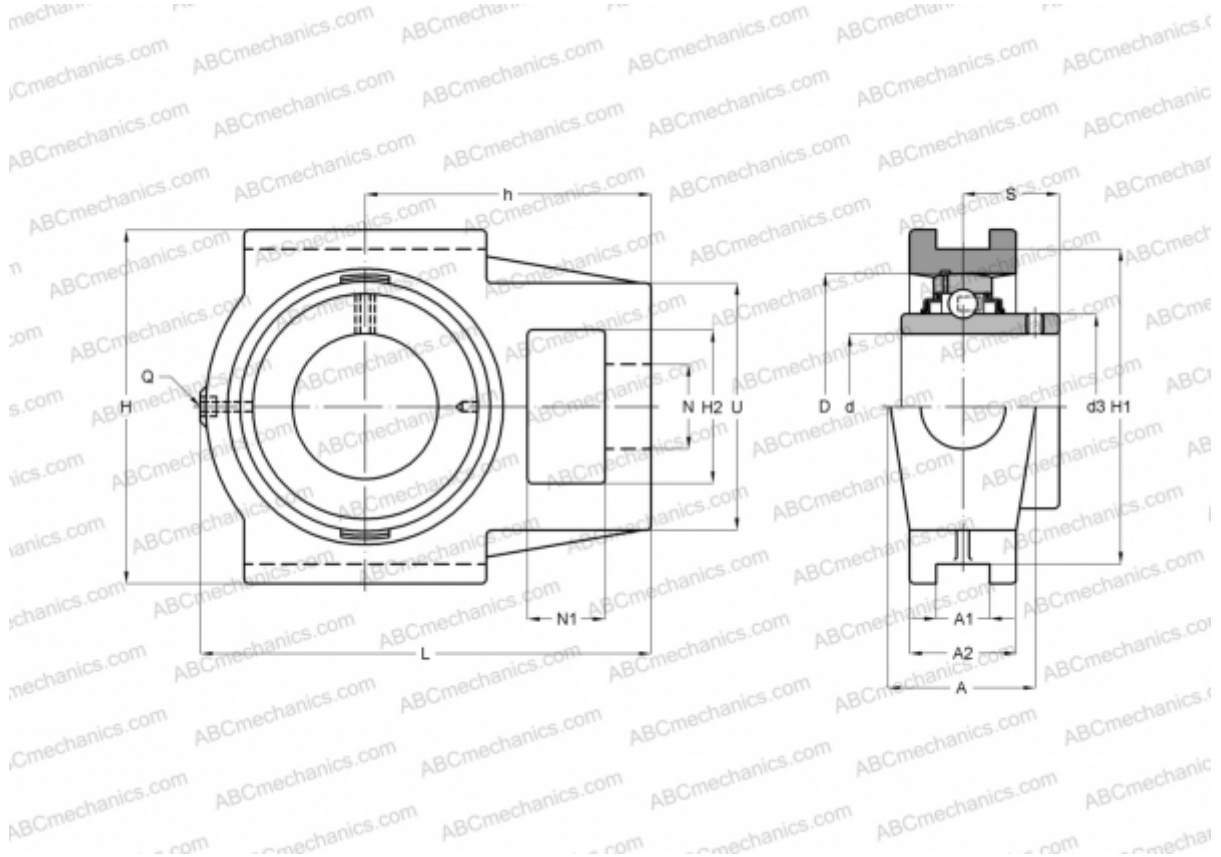

Technical specification

DIMENSIONS, MM

d	100,000
D	215,000
B	108,000
L	345,000
H	290,000
A	120,000
H2	115,000
A1	35,000
A2	75,000
H1	260,000
N	59,000
N1	48,000
S	66,000
d3	135,500
U	175,000

DIMENSIONS, MM

h	210,000
---	---------

WEIGHT, KG

Bearing	UC 320
Housing	T 320

MANUFACTURER

[ASAHI](#)