

UCT 322 ASAHI

Ball bearing units

TYPE: Housing units, Take-up housing units, Cast iron housing, Radial insert ball bearing with grub screws in inner ring, Type UCT (ASAHI)

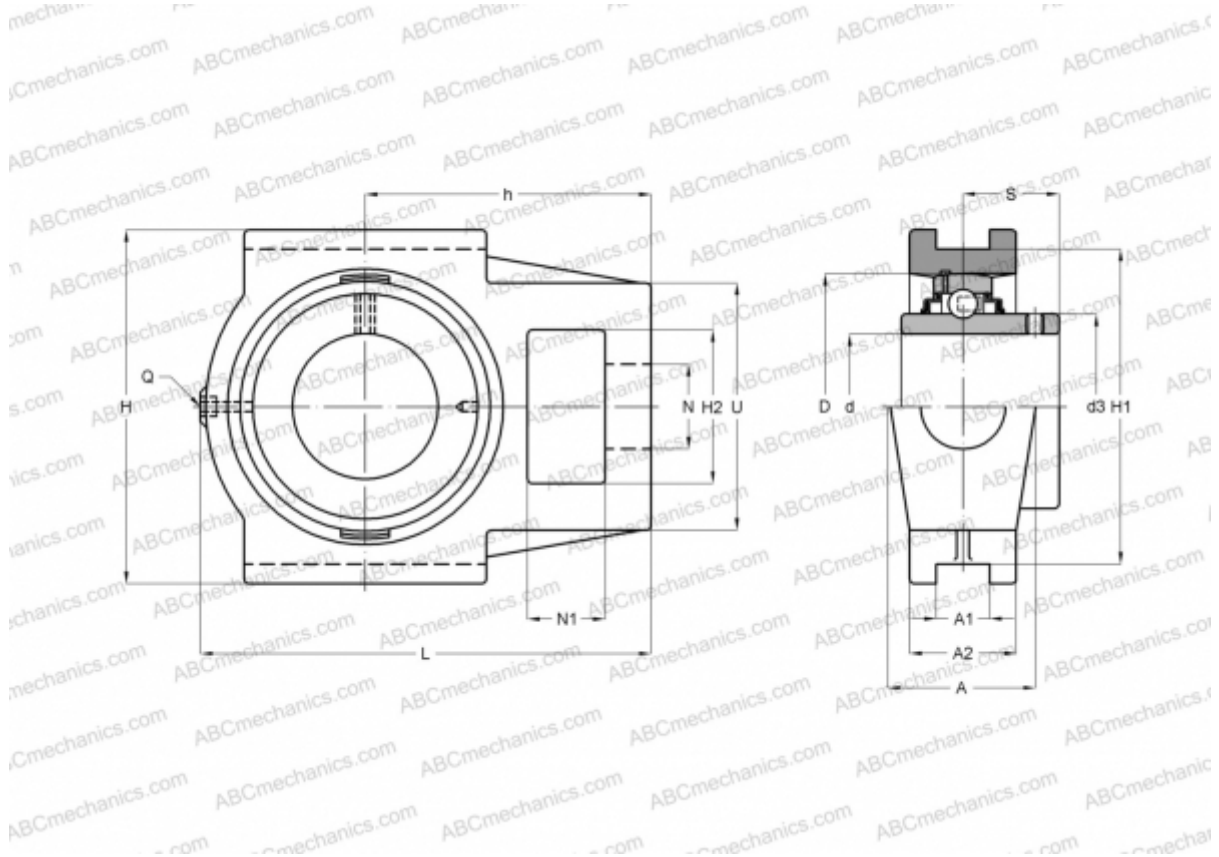

Technical specification

DIMENSIONS, MM

d	110,000
D	240,000
B	117,000
L	385,000
H	320,000
A	130,000
H2	125,000
A1	38,000
A2	80,000
H1	285,000
N	65,000
N1	52,000
S	71,000
d3	152,000
U	185,000

DIMENSIONS, MM

h	735,000
---	---------

WEIGHT, KG

Bearing	UC 322
Housing	T 322

MANUFACTURER

[ASAHI](#)