

UCT 324 ASAHI

Ball bearing units

TYPE: Housing units, Take-up housing units, Cast iron housing, Radial insert ball bearing with grub screws in inner ring, Type UCT (ASAHI)

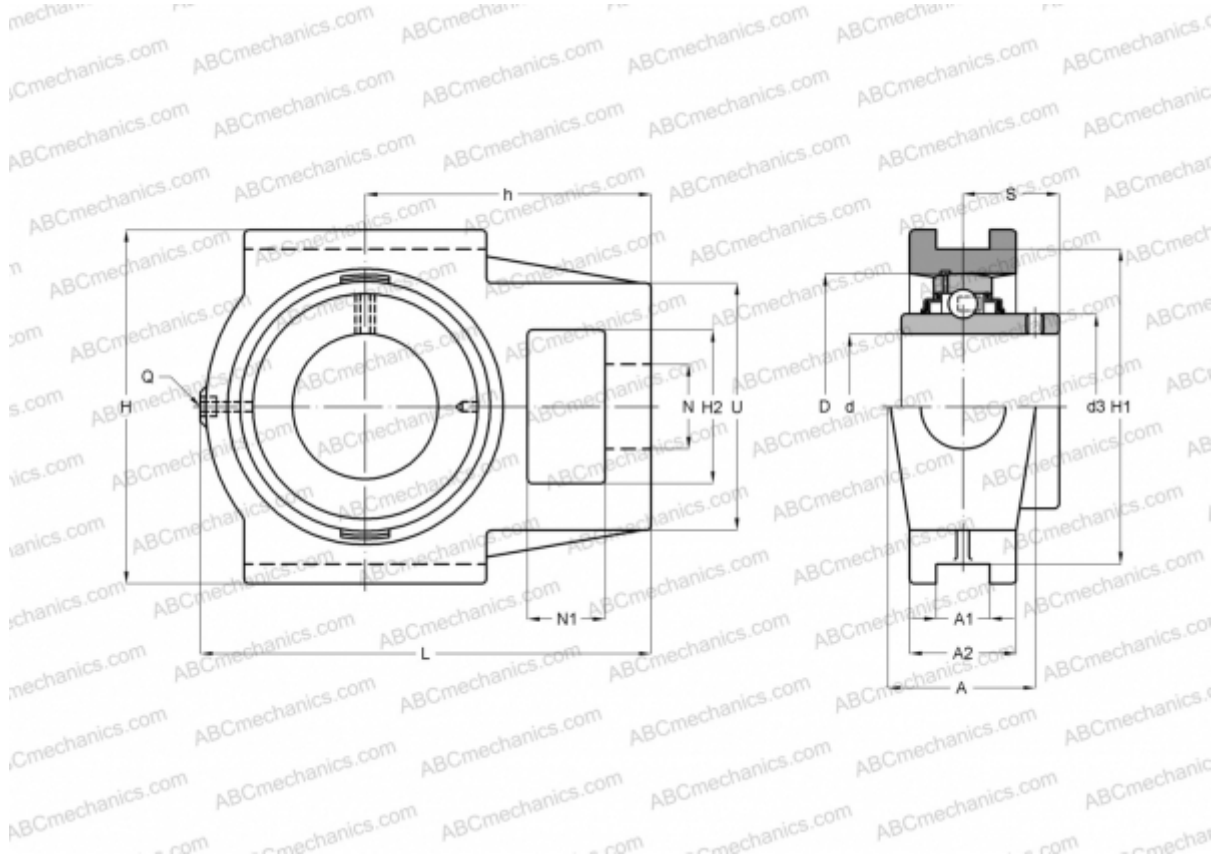

Technical specification

DIMENSIONS, MM

d	120,000
D	260,000
B	126,000
L	432,000
H	355,000
A	140,000
H2	140,000
A1	45,000
A2	90,000
H1	320,000
N	70,000
N1	60,000
S	75,000
d3	165,000
U	210,000

DIMENSIONS, MM

h	267,000
---	---------

WEIGHT, KG

Bearing	UC 324
Housing	T 324

MANUFACTURER

[ASAHI](#)