

## UCST 205 ASAHI

Ball bearing units

TYPE: Housing units, Take-up housing units, Cast iron housing, Radial insert ball bearing with grub screws in inner ring, Type UCST (ASAHI)

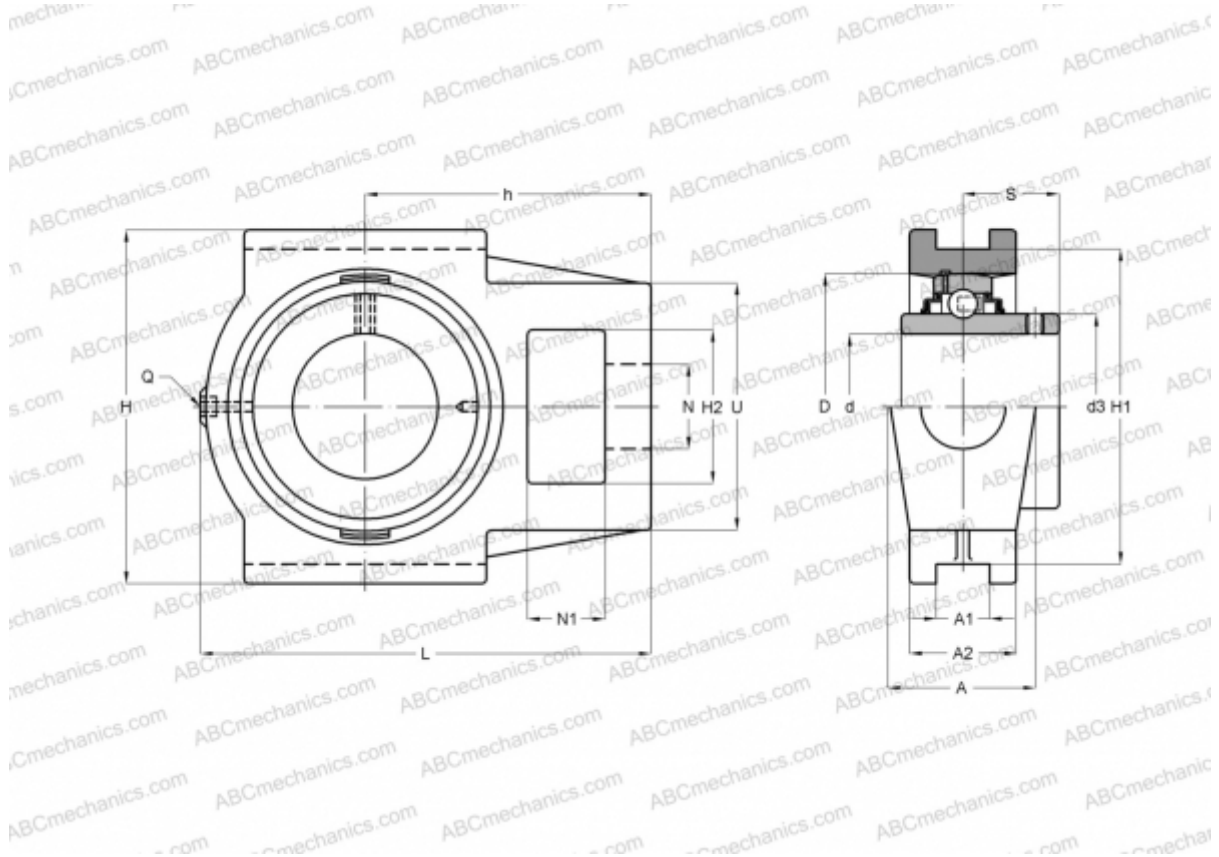

### Technical specification

#### DIMENSIONS, MM

d	25,000
D	52,000
B	34,100
L	97,000
H	89,000
A	32,000
H2	32,000
A1	13,500
A2	24,000
H1	76,200
N	22,000
N1	16,000
S	19,800
d3	34,000
U	51,000

#### DIMENSIONS, MM

h	62,000
---	--------

#### WEIGHT, KG

0,800	
Bearing	UC 205
Housing	ST 205

#### MANUFACTURER

[ASAHI](#)