

## UCST 213 ASAHI

Ball bearing units

TYPE: Housing units, Take-up housing units, Cast iron housing, Radial insert ball bearing with grub screws in inner ring, Type UCST (ASAHI)

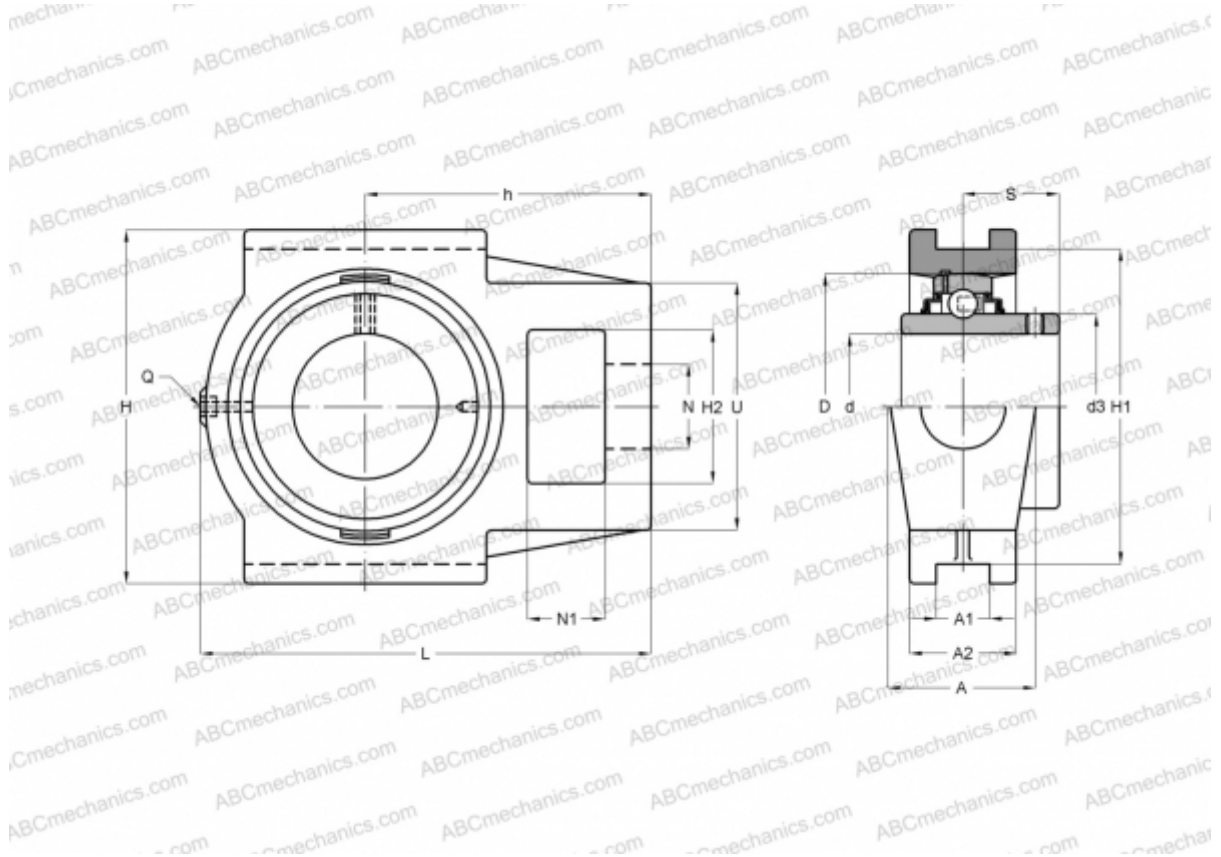

### Technical specification

#### DIMENSIONS, MM

d	65,000
D	120,000
B	65,100
L	224,000
H	167,000
A	70,000
H2	70,000
A1	27,000
A2	51,000
H1	150,800
N	41,000
N1	32,000
S	39,700
d3	82,100
U	111,000

#### DIMENSIONS, MM

h	137,000
---	---------

#### WEIGHT, KG

	7,100
Bearing	UC 213
Housing	ST 213

#### MANUFACTURER

[ASAHI](#)