

UCT X06 ASAHI

Ball bearing units

TYPE: Housing units, Take-up housing units, Cast iron housing, Radial insert ball bearing with grub screws in inner ring, Type UCTX (ASAHI)

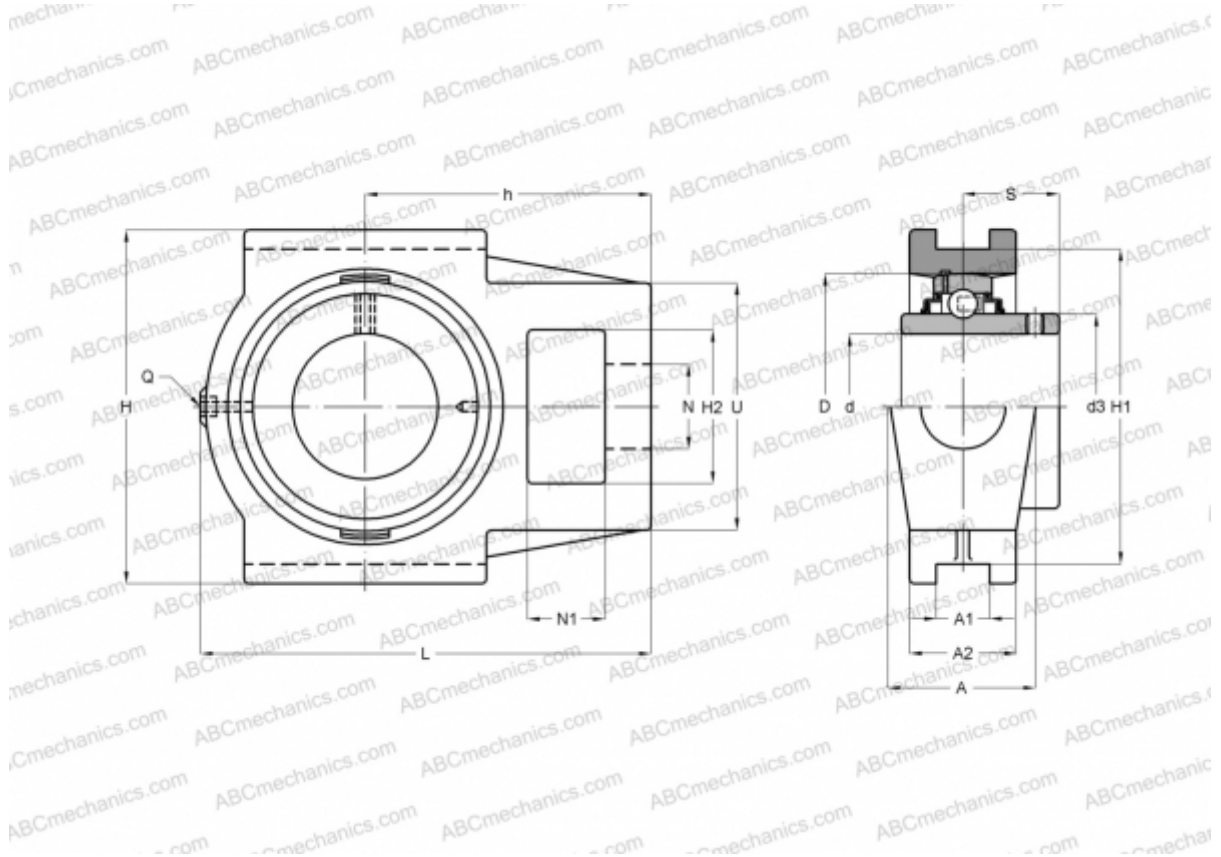

Technical specification

DIMENSIONS, MM

d	30,000
D	72,000
B	42,900
L	129,000
H	102,000
A	37,000
H2	37,000
A1	12,000
A2	30,000
H1	89,000
N	22,000
N1	16,000
S	25,400
d3	48,000
U	64,000

DIMENSIONS, MM

l	64,000
h	78,000

WEIGHT, KG

Bearing	UC X06
Housing	T X06

MANUFACTURER

[ASAHI](#)