

UCT X07 ASAHI

Ball bearing units

TYPE: Housing units, Take-up housing units, Cast iron housing, Radial insert ball bearing with grub screws in inner ring, Type UCTX (ASAHI)

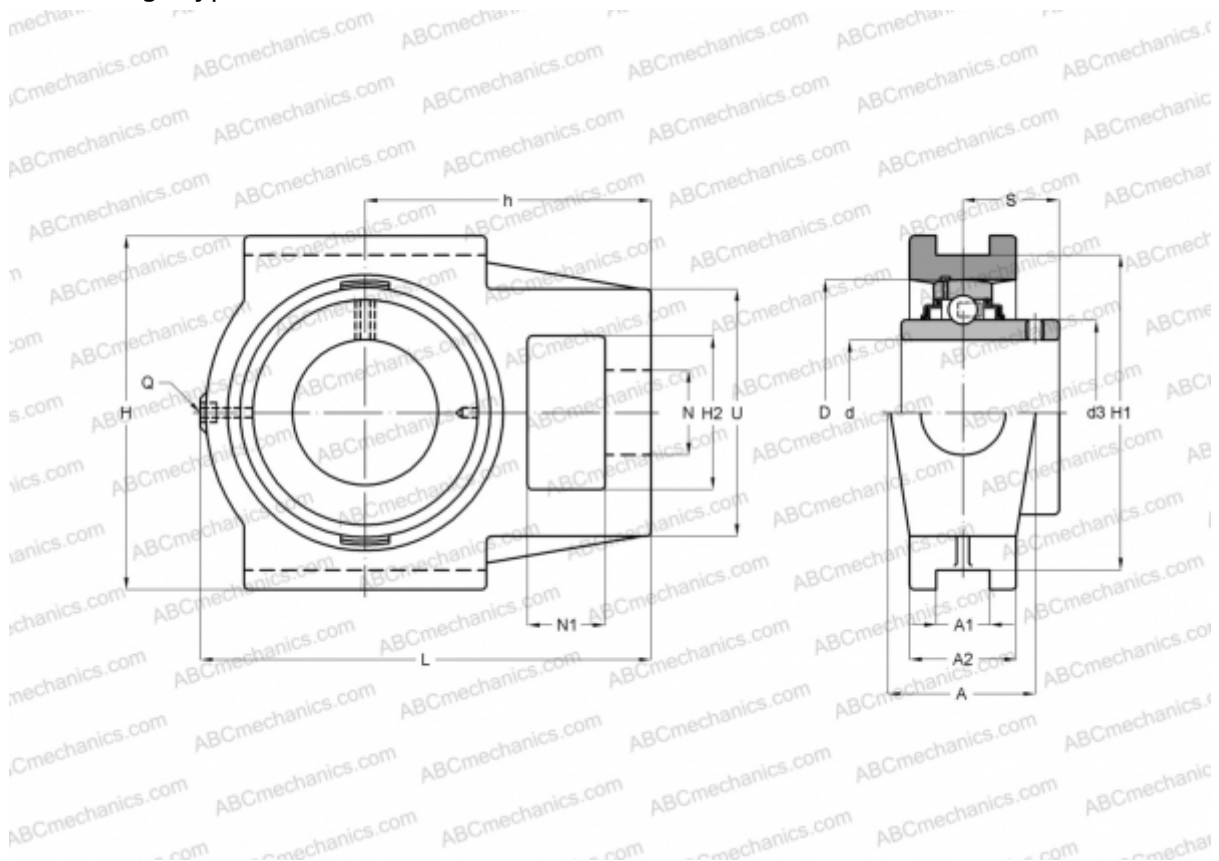

Technical specification

DIMENSIONS, MM

d	35,000
D	80,000
B	49,200
L	144,000
H	114,000
A	49,000
H2	49,000
A1	16,000
A2	36,000
H1	102,000
N	29,000
N1	19,000
S	30,200
d3	53,000
U	83,000

DIMENSIONS, MM

l	83,000
h	88,000

WEIGHT, KG

Bearing	UC X07
Housing	T X07

MANUFACTURER

[ASAHI](http://www.asahi.com)