

UCT X09 ASAHI

Ball bearing units

TYPE: Housing units, Take-up housing units, Cast iron housing, Radial insert ball bearing with grub screws in inner ring, Type UCTX (ASAHI)

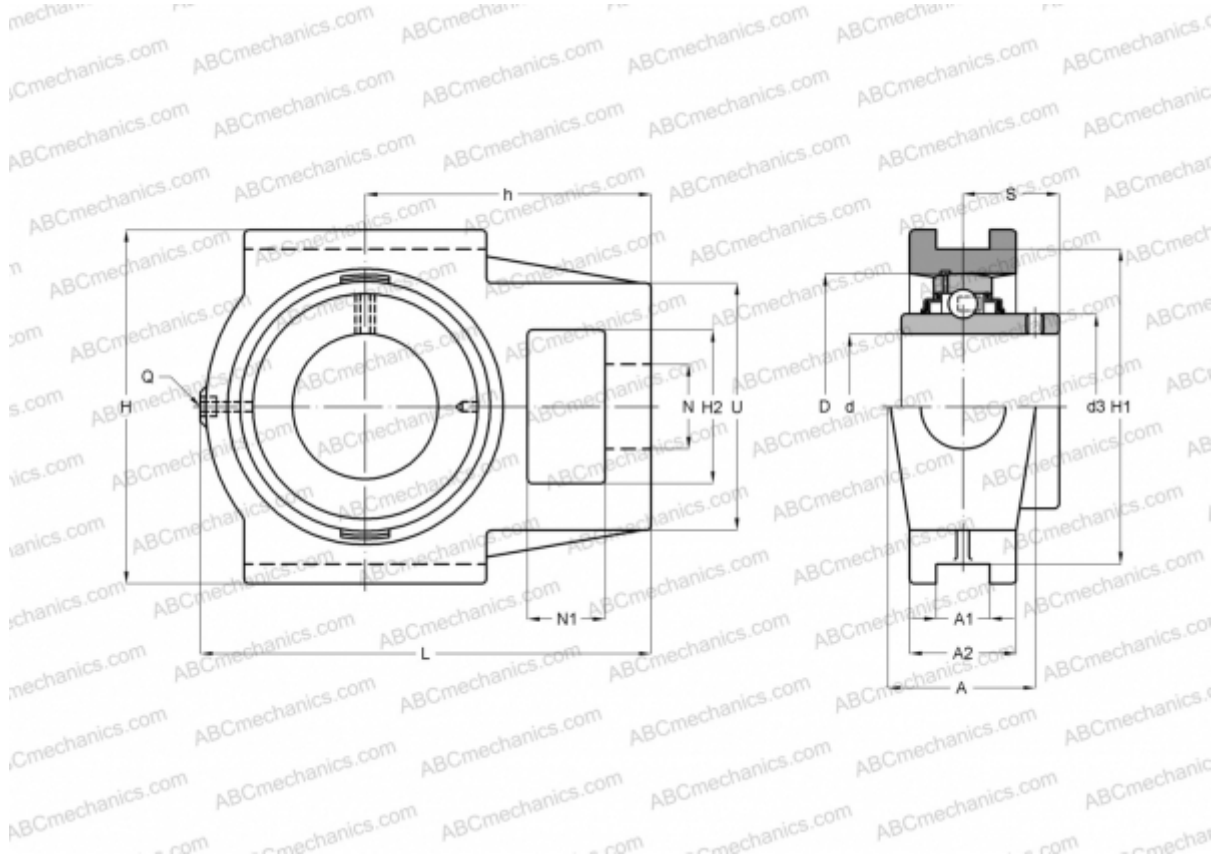

Technical specification

DIMENSIONS, MM

d	45,000
D	90,000
B	51,600
L	149,000
H	117,000
A	49,000
H2	49,000
A1	16,000
A2	38,000
H1	102,000
N	29,000
N1	19,000
S	32,600
d3	63,000
U	83,000

DIMENSIONS, MM

l	86,000
h	90,000

WEIGHT, KG

Bearing	UC X09
Housing	T X09

MANUFACTURER

[ASAHI](#)