

UCT X13 ASAHI

Ball bearing units

TYPE: Housing units, Take-up housing units, Cast iron housing, Radial insert ball bearing with grub screws in inner ring, Type UCTX (ASAHI)

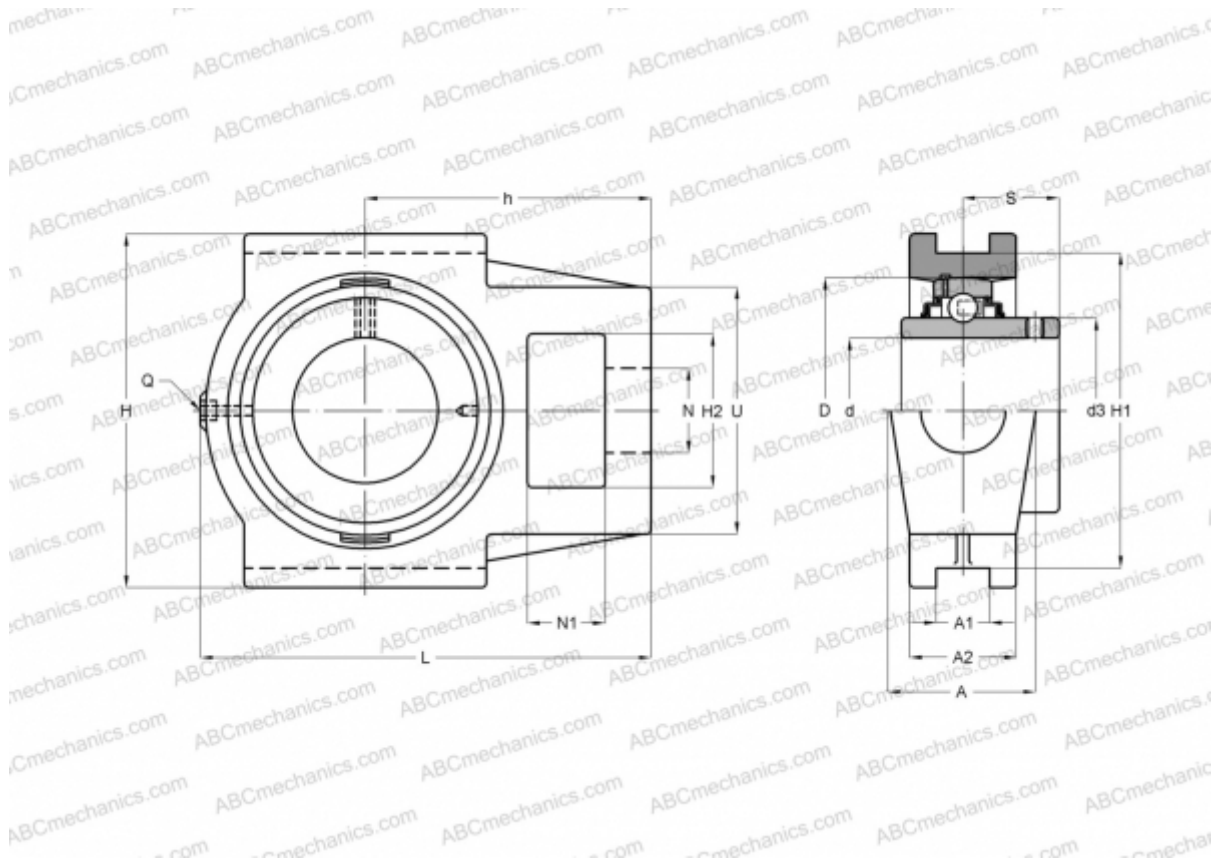

Technical specification

DIMENSIONS, MM

d	65,000
D	125,000
B	74,600
L	224,000
H	167,000
A	70,000
H2	70,000
A1	26,000
A2	48,000
H1	151,000
N	41,000
N1	32,000
S	44,400
d3	87,000
U	111,000

DIMENSIONS, MM

l	121,000
h	137,000

WEIGHT, KG

Bearing	UC X13
Housing	T X13

MANUFACTURER

[ASAHI](#)