

UCT X16 ASAHI

Ball bearing units

TYPE: Housing units, Take-up housing units, Cast iron housing, Radial insert ball bearing with grub screws in inner ring, Type UCTX (ASAHI)

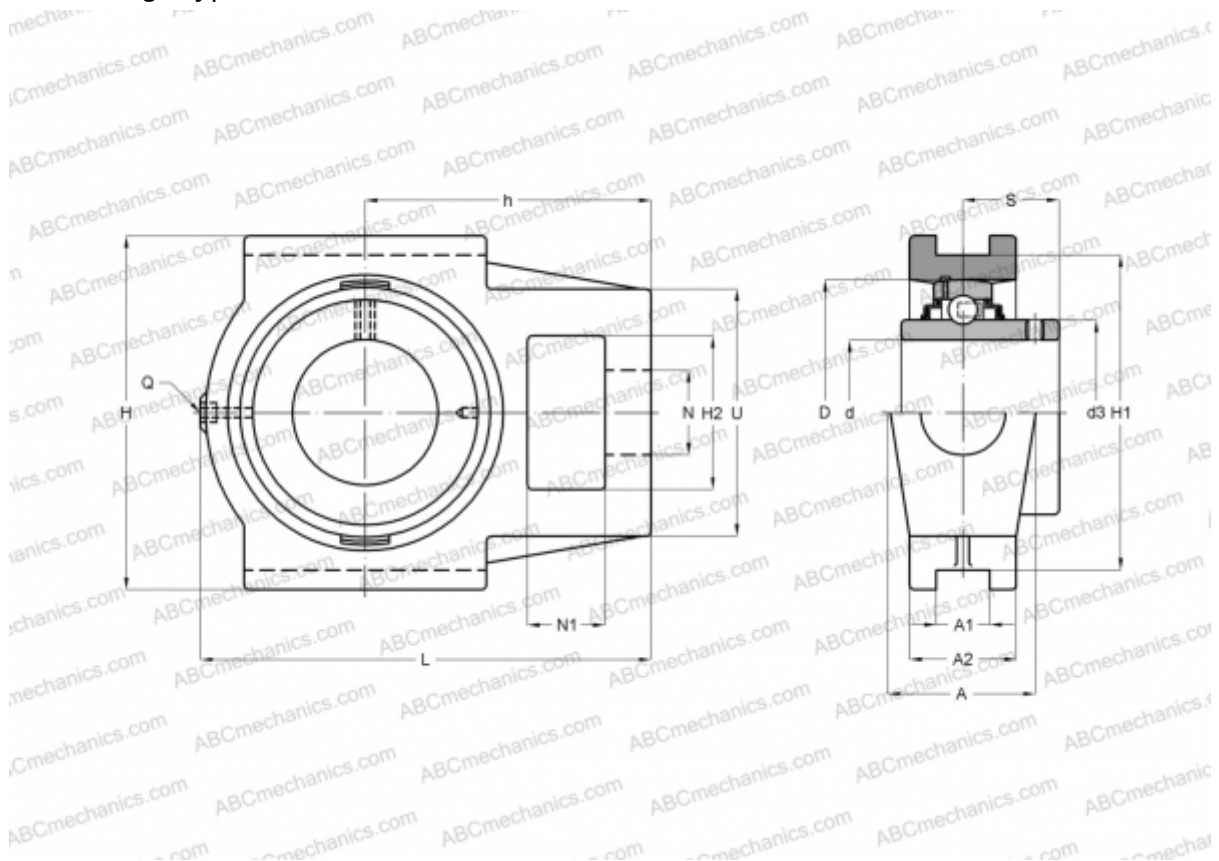

Technical specification

DIMENSIONS, MM

d	80,000
D	150,000
B	85,700
L	260,000
H	198,000
A	73,000
H2	73,000
A1	28,000
A2	54,000
H1	173,000
N	48,000
N1	38,000
S	51,600
d3	105,000
U	124,000

DIMENSIONS, MM

l	157,000
h	162,000

WEIGHT, KG

Bearing	UC X16
Housing	T X16

MANUFACTURER

[ASAHI](#)