

UCECH 205 ASAHI

Ball bearing units

TYPE: Housing units, Hanger unit, Cast iron housing, Radial insert ball bearing with grub screws in inner ring, Type UCECH (ASAHI)

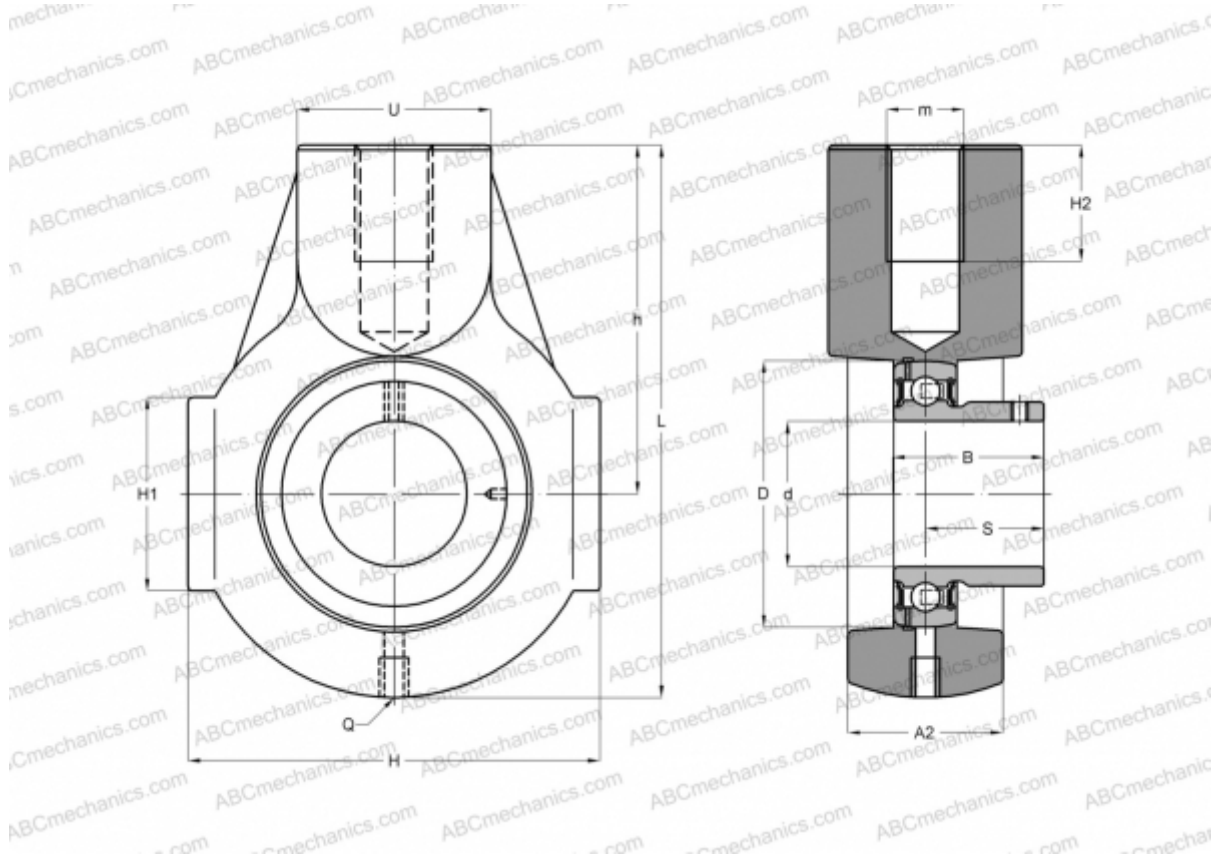

Technical specification

DIMENSIONS, MM

d	25,000
D	52,000
B	34,100
L	99,000
H	70,000
H2	19,000
S	19,800
U	40,000
h	64,000

WEIGHT, KG 0,740

Bearing	UC 205
Housing	ECH 205

MANUFACTURER

[ASAHI](#)