

UCECH 207 ASAHI

Ball bearing units

TYPE: Housing units, Hanger unit, Cast iron housing, Radial insert ball bearing with grub screws in inner ring, Type UCECH (ASAHI)

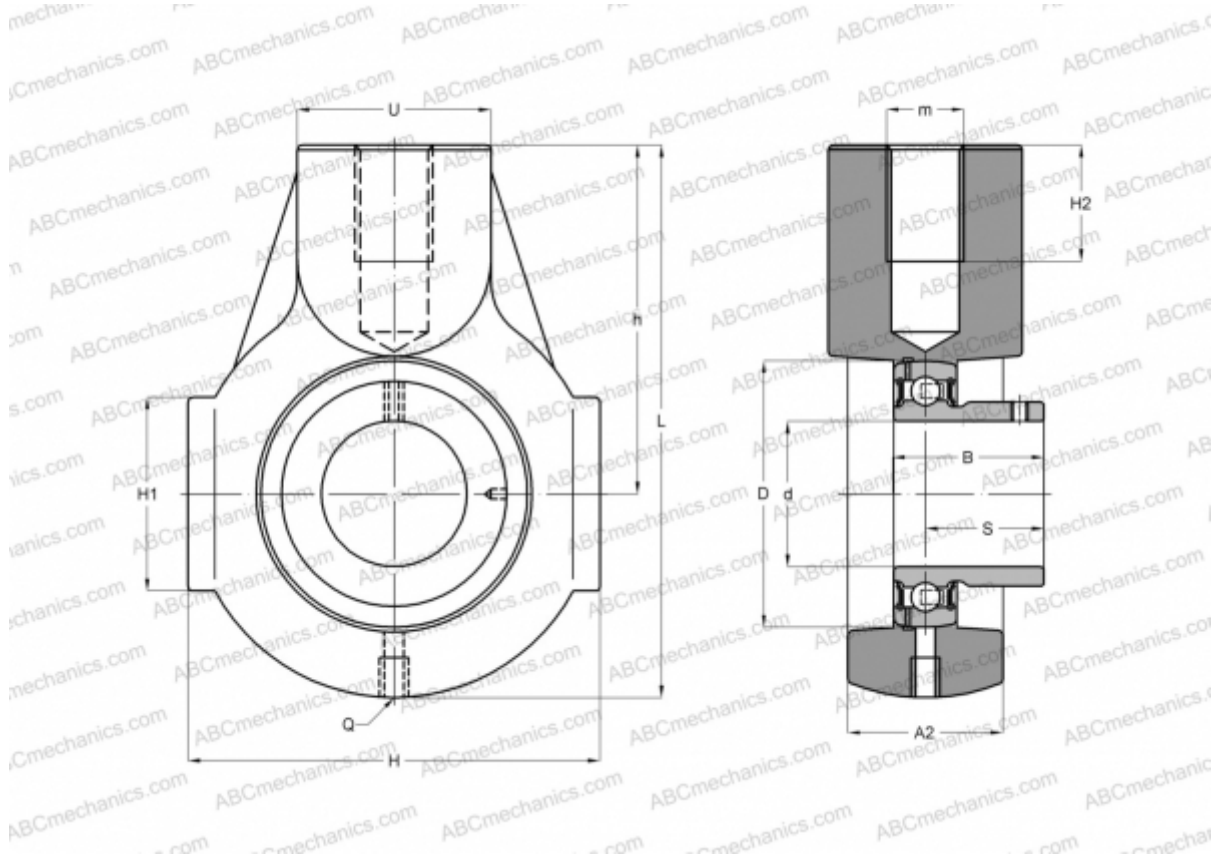

Technical specification

DIMENSIONS, MM

d	35,000
D	72,000
B	42,900
L	116,000
H	92,000
H2	19,000
S	25,400
U	40,000
h	70,000

WEIGHT, KG 1,200

Bearing	UC 207
Housing	ECH 207

MANUFACTURER

[ASAHI](#)