

UCP 210 ASAHI

Ball bearing units

TYPE: Housing units, Plummer block, Cast iron housing, Radial insert ball bearing with grub screws in inner ring, Type UCP (ASAHI)

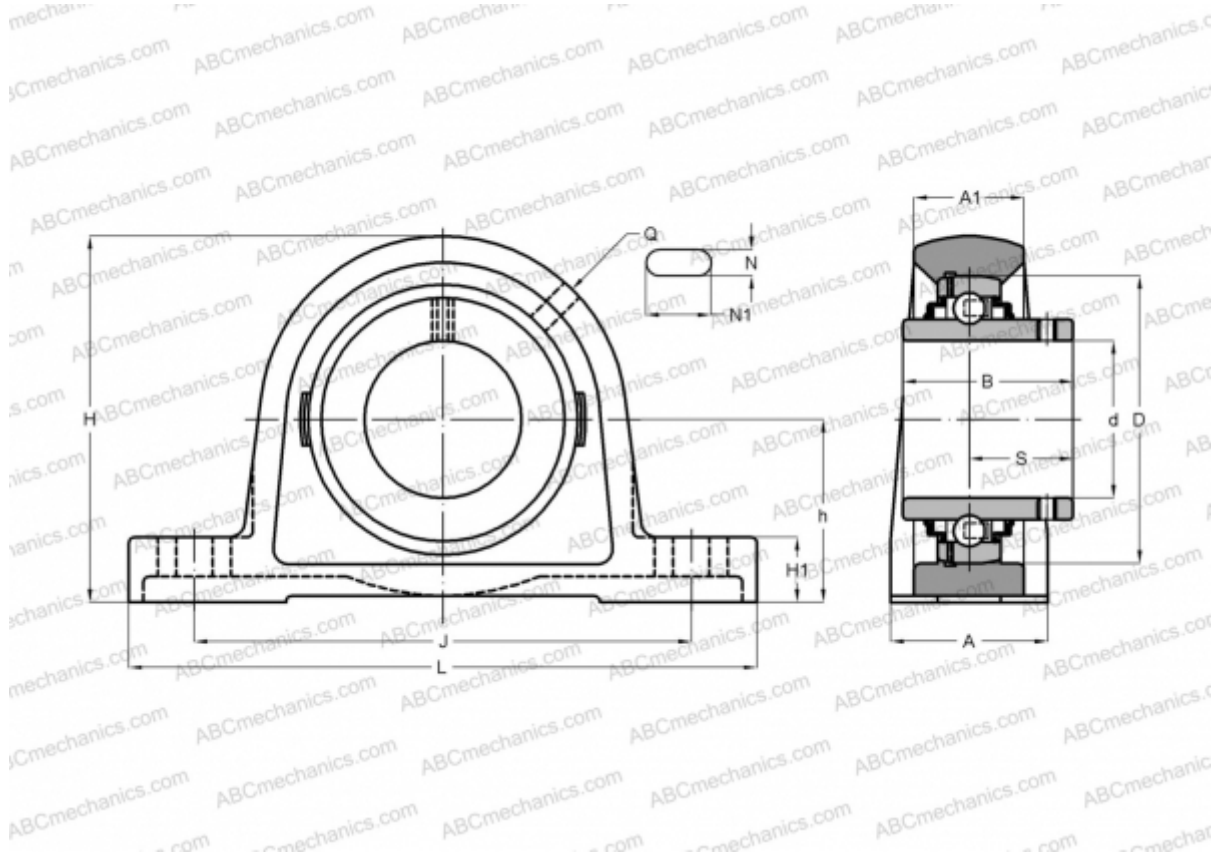

Technical specification

DIMENSIONS, MM

d	50,000
D	90,000
B	51,600
L	206,000
H	114,000
A	60,000
J	159,000
H1	22,000
N	20,000
N1	25,000
S	32,600
h	57,200

WEIGHT, KG

2,700

Bearing	UC 210
Housing	P 210

MANUFACTURER

[ASAHI](#)