

UCP 218 ASAHI

Ball bearing units

TYPE: Housing units, Plummer block, Cast iron housing, Radial insert ball bearing with grub screws in inner ring, Type UCP (ASAHI)

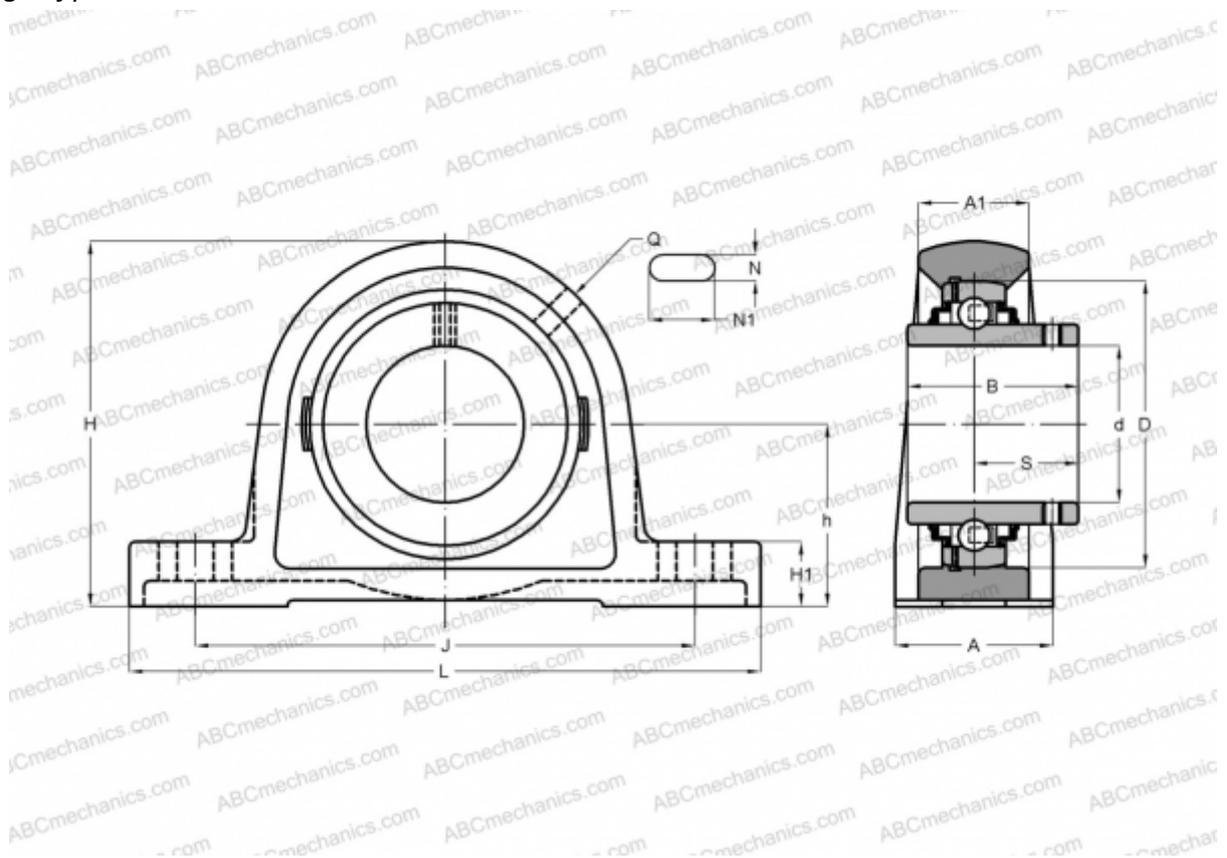

Technical specification

DIMENSIONS, MM

d	90,000
D	160,000
B	96,000
L	327,000
H	200,000
A	88,000
J	262,000
H1	34,000
N	27,000
N1	33,000
S	56,300
h	101,600

WEIGHT, KG

14,700

Bearing

UC 218

Housing

P 218

MANUFACTURER

[ASAHI](#)