

UCLP 208 ASAHI

Ball bearing units

TYPE: Housing units, Plummer block, Cast iron housing, Radial insert ball bearing with grub screws in inner ring, Type UCLP (ASAHI)

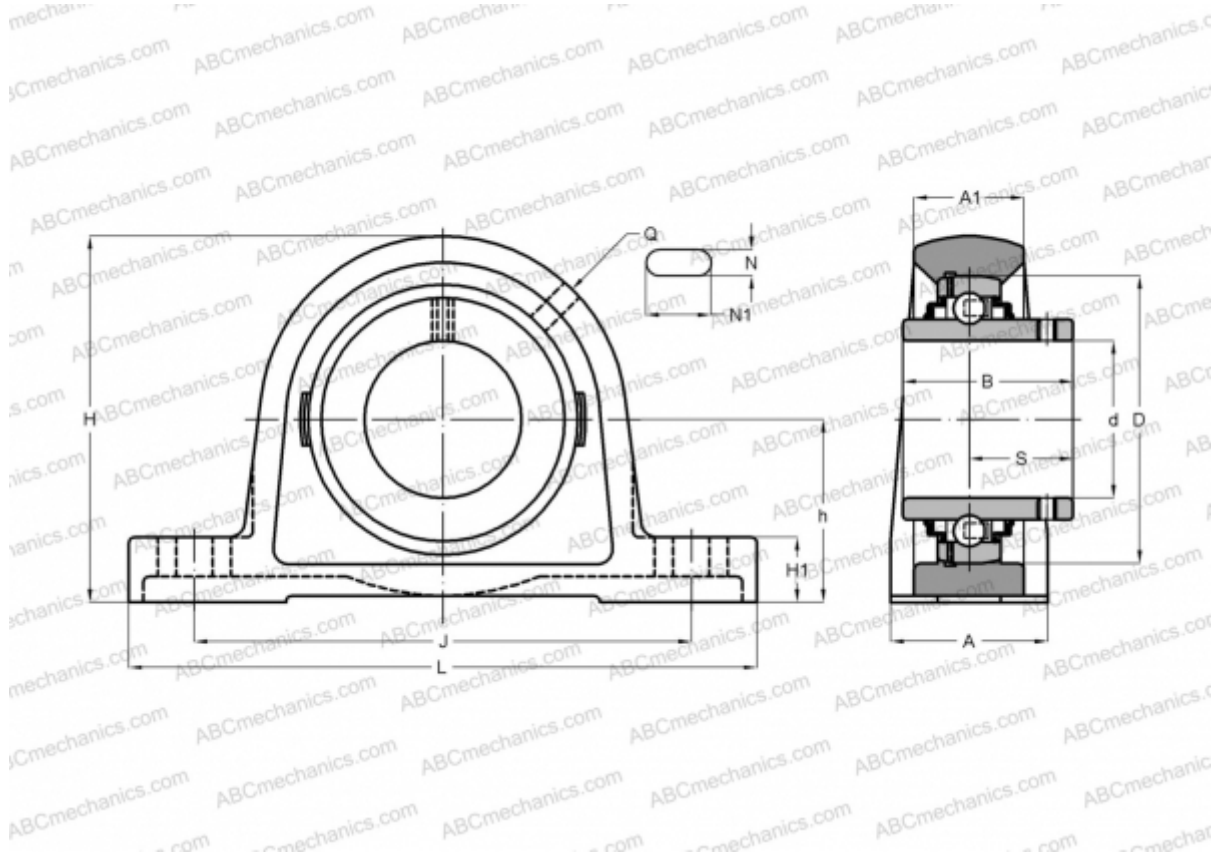

Technical specification

DIMENSIONS, MM

d	40,000
D	80,000
B	49,200
L	184,000
H	100,000
A	51,000
J	143,000
H1	21,000
N	15,000
N1	22,000
S	30,200
h	49,200

WEIGHT, KG

2,000

Bearing	UC 208
Housing	LP 208

MANUFACTURER

[ASAHI](#)