

UCLP 210 ASAHI

Ball bearing units

TYPE: Housing units, Plummer block, Cast iron housing, Radial insert ball bearing with grub screws in inner ring, Type UCLP (ASAHI)

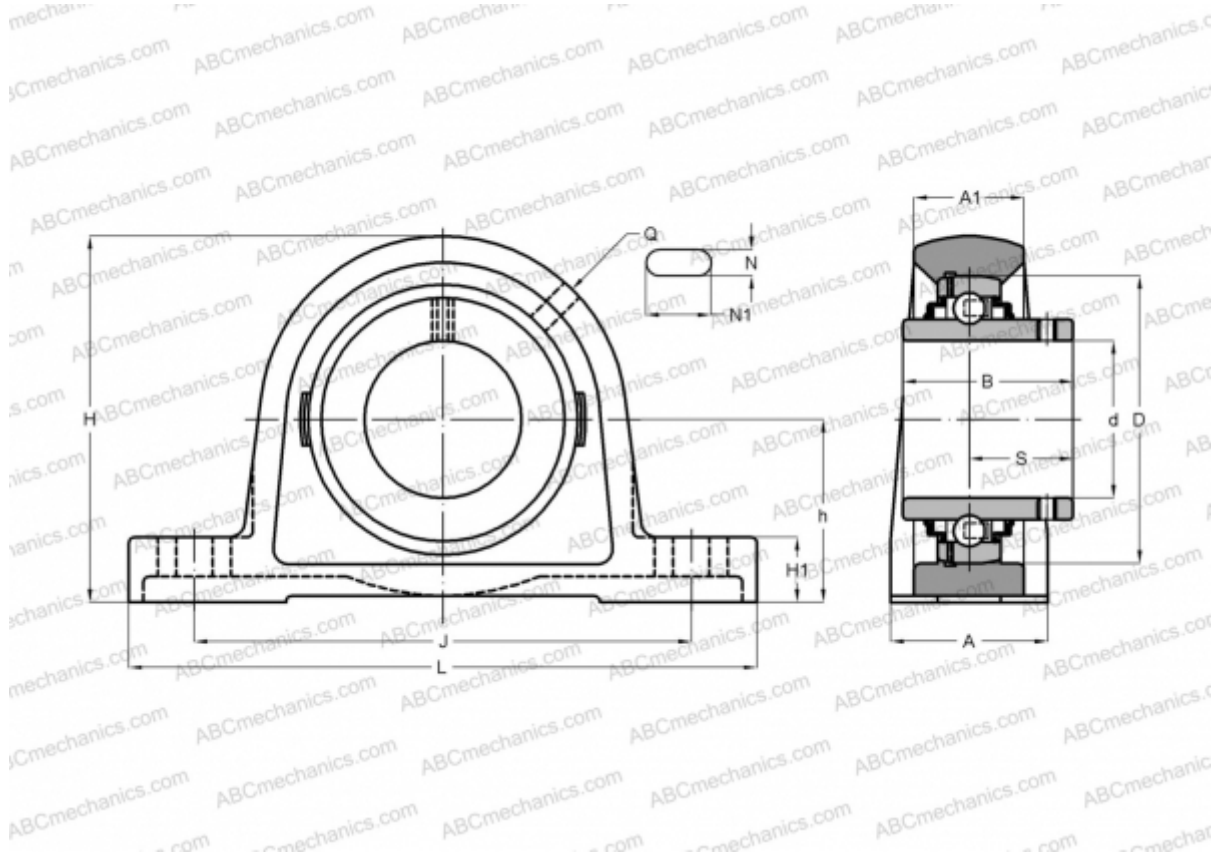

Technical specification

DIMENSIONS, MM

d	50,000
D	90,000
B	51,600
L	213,000
H	113,000
A	57,000
J	165,000
H1	22,000
N	15,000
N1	25,000
S	32,600
h	55,600

WEIGHT, KG

2,700

Bearing	UC 210
Housing	LP 210

MANUFACTURER

[ASAHI](#)