

UCLP 213 ASAHI

Ball bearing units

TYPE: Housing units, Plummer block, Cast iron housing, Radial insert ball bearing with grub screws in inner ring, Type UCLP (ASAHI)

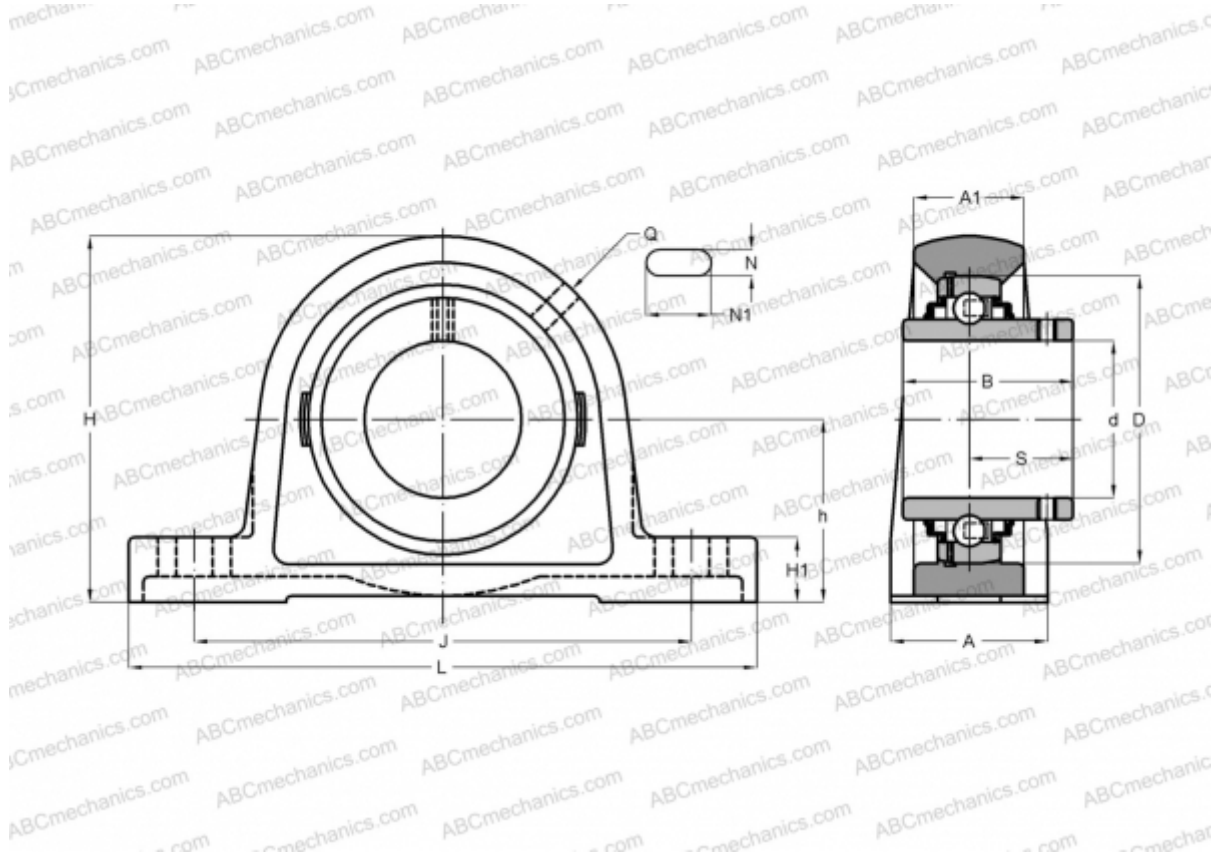

Technical specification

DIMENSIONS, MM

d	65,000
D	120,000
B	65,100
L	248,000
H	138,000
A	70,000
J	194,000
H1	29,000
N	19,000
N1	29,000
S	39,700
h	68,300

WEIGHT, KG

5,600

Bearing	UC 213
Housing	LP 213

MANUFACTURER

[ASAHI](#)