

UDP 210 ASAHI

Ball bearing units

TYPE: Housing units, Plummer block, Cast iron housing, Radial insert ball bearing with eccentric locking collar, Type UDP (ASAHI)

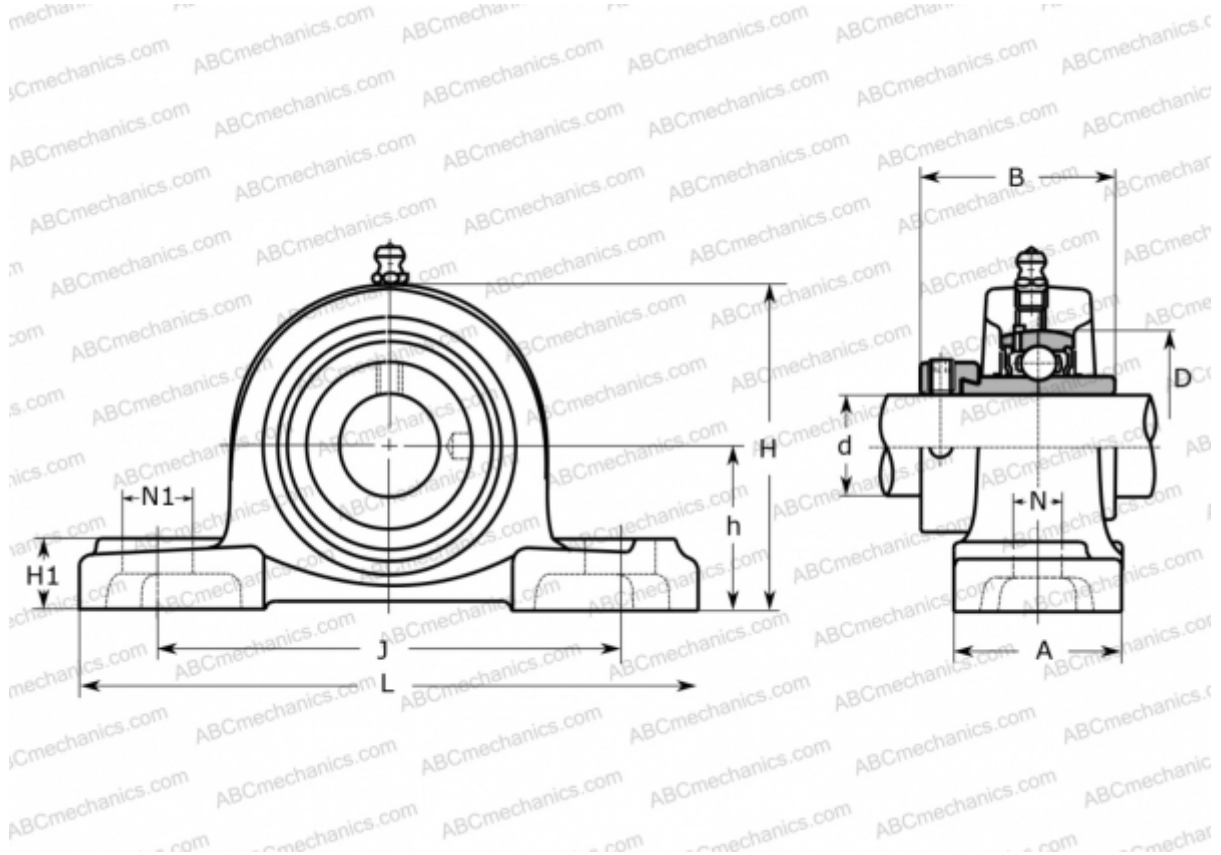

Technical specification

DIMENSIONS, MM

d	50,000
D	90,000
B	43,000
L	206,000
H	114,000
A	60,000
J	159,000
H1	22,000
N	20,000
N1	25,000
h	57,200

WEIGHT, KG

2,600

Bearing

UD 210 + EE

Housing

P 210

MANUFACTURER

[ASAHI](http://www.asahi.com)