

## CUCP 202C ASAHI

Ball bearing units

TYPE: Housing units, Plummer block, Cast iron housing, Radial insert ball bearing with grub screws in inner ring, Type CUCP..C with cast iron covers, open cover (ASAHI)

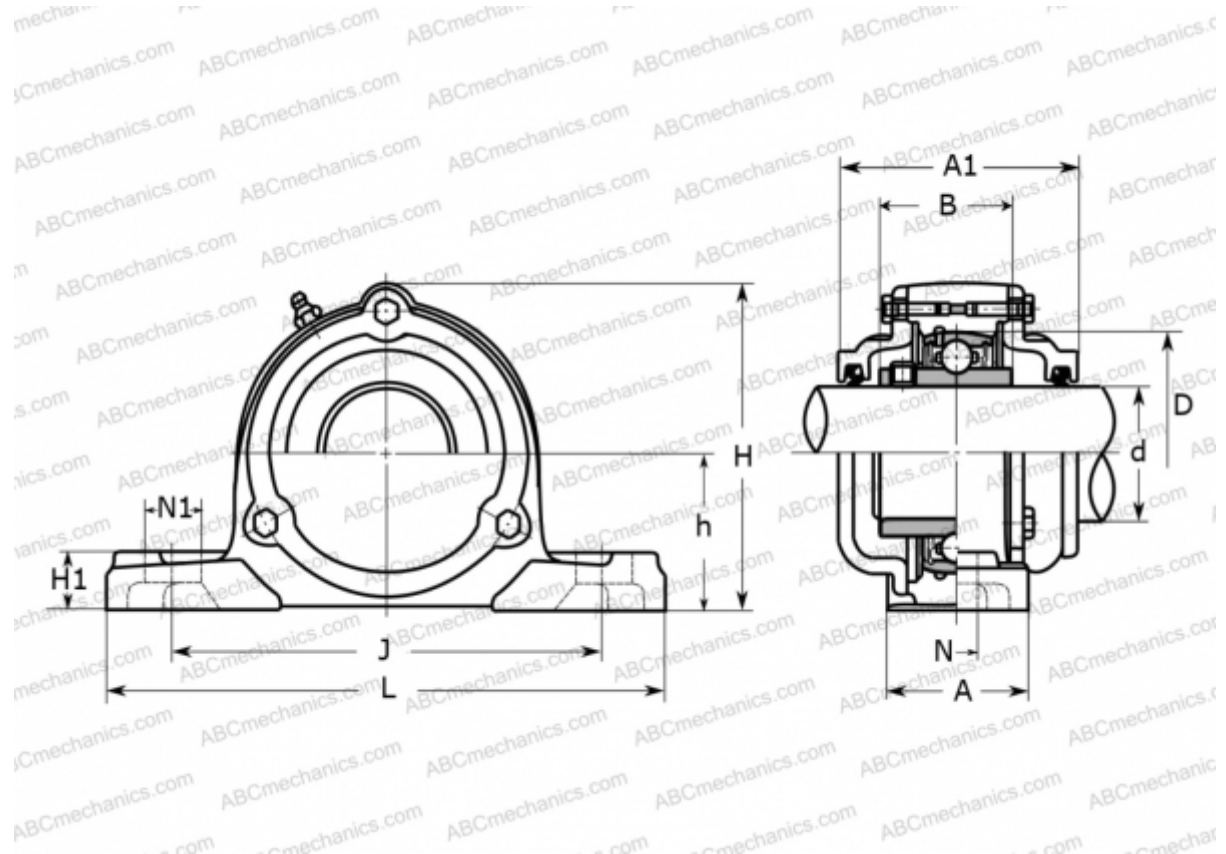

### Technical specification

#### DIMENSIONS, MM

d	15,000
D	47,000
B	31,000
L	127,000
H	66,000
A	38,000
J	95,000
A1	62,000
H1	15,000
N	13,000
N1	19,000
h	30,200

#### WEIGHT, KG

1,100

Bearing

UC 202

Housing

CP 203

#### MANUFACTURER

[ASAHI](http://www.asahi.com)