

CUCP 204C ASAHI

Ball bearing units

TYPE: Housing units, Plummer block, Cast iron housing, Radial insert ball bearing with grub screws in inner ring, Type CUCP..C with cast iron covers, open cover (ASAHI)

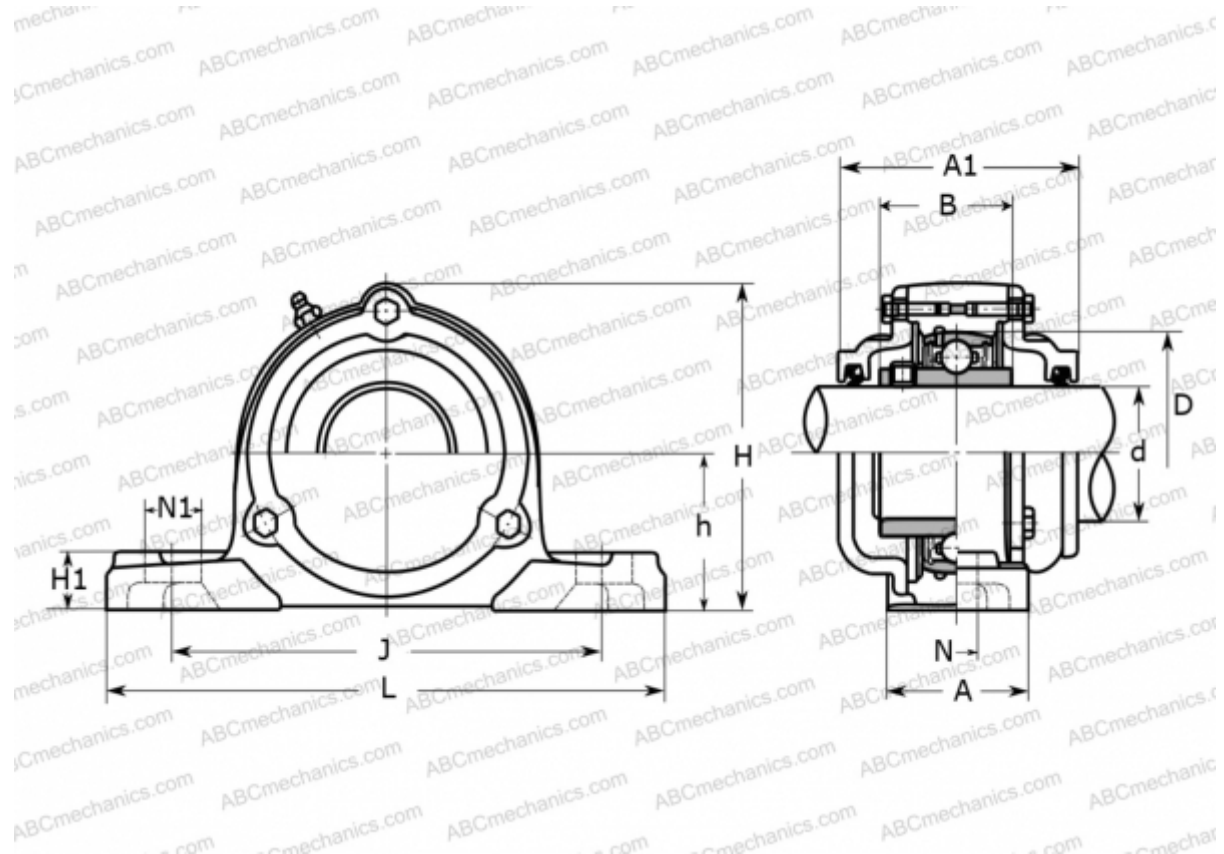

Technical specification

DIMENSIONS, MM

d	20,000
D	47,000
B	31,000
L	127,000
H	69,000
A	38,000
J	95,000
A1	62,000
H1	15,000
N	13,000
N1	19,000
h	33,300

WEIGHT, KG

1,100

Bearing	UC 204
Housing	CP 204

MANUFACTURER

[ASAHI](http://www.asahi.com)