

CUCP 205C ASAHI

Ball bearing units

TYPE: Housing units, Plummer block, Cast iron housing, Radial insert ball bearing with grub screws in inner ring, Type CUCP..C with cast iron covers, open cover (ASAHI)

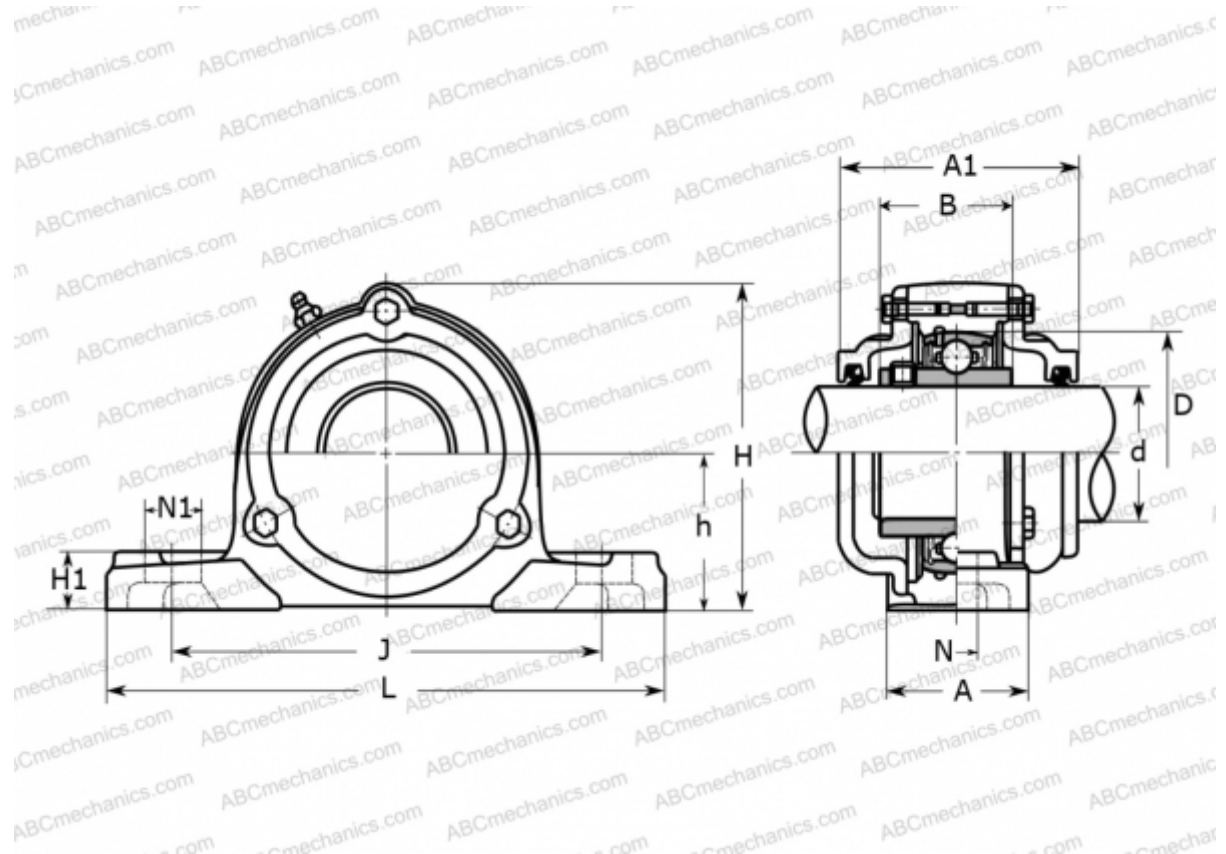

Technical specification

DIMENSIONS, MM

d	25,000
D	52,000
B	34,100
L	140,000
H	76,000
A	38,000
J	105,000
A1	70,000
H1	16,000
N	13,000
N1	16,000
h	36,500

WEIGHT, KG

1,400

Bearing

UC 205

Housing

CP 205

MANUFACTURER

[ASAHI](http://www.asahi.com)