

CUCP 206C ASAHI

Ball bearing units

TYPE: Housing units, Plummer block, Cast iron housing, Radial insert ball bearing with grub screws in inner ring, Type CUCP..C with cast iron covers, open cover (ASAHI)

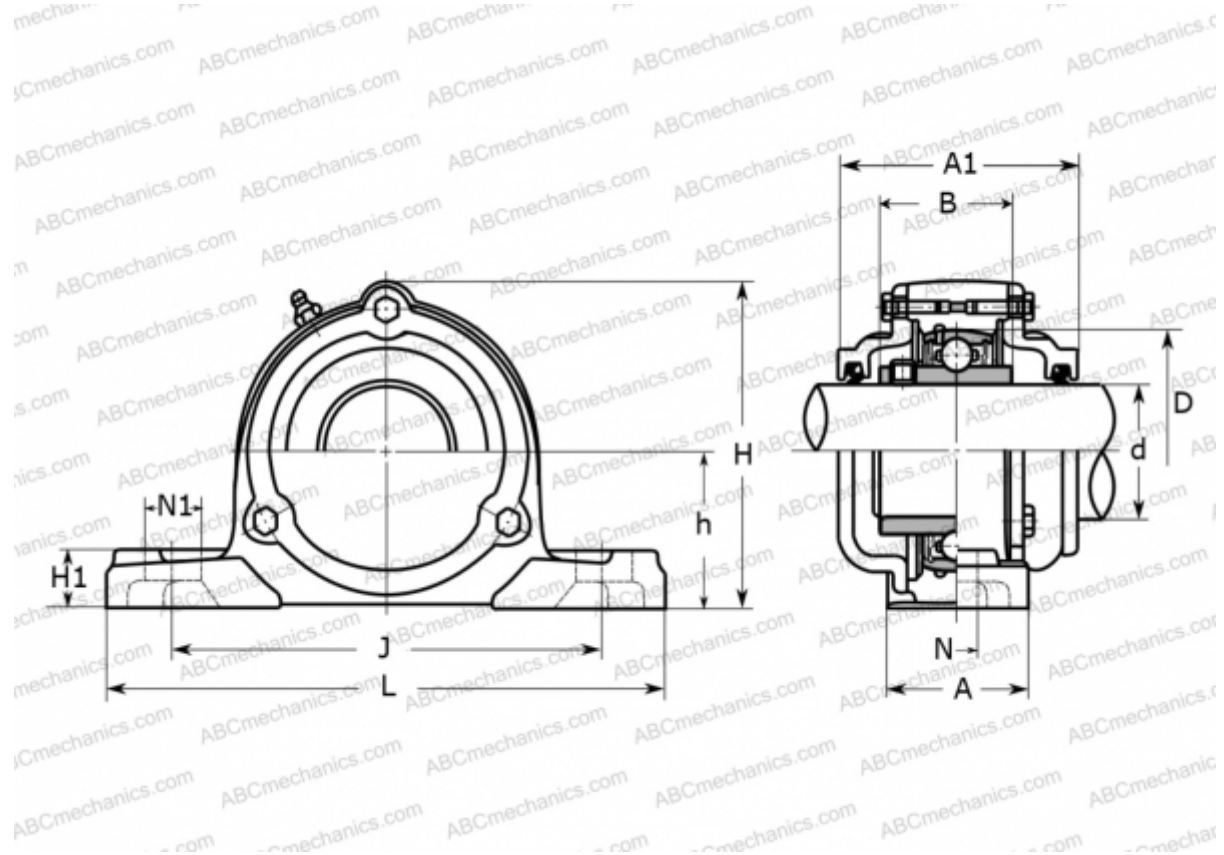

Technical specification

DIMENSIONS, MM

d	30,000
D	62,000
B	38,100
L	165,000
H	87,000
A	48,000
J	121,000
A1	74,000
H1	18,000
N	17,000
N1	21,000
h	42,900

WEIGHT, KG

2,000

Bearing	UC 206
Housing	CP 206

MANUFACTURER

[ASAHI](http://www.asahi.com)