

## CUCP 209C ASAHI

Ball bearing units

TYPE: Housing units, Plummer block, Cast iron housing, Radial insert ball bearing with grub screws in inner ring, Type CUCP..C with cast iron covers, open cover (ASAHI)

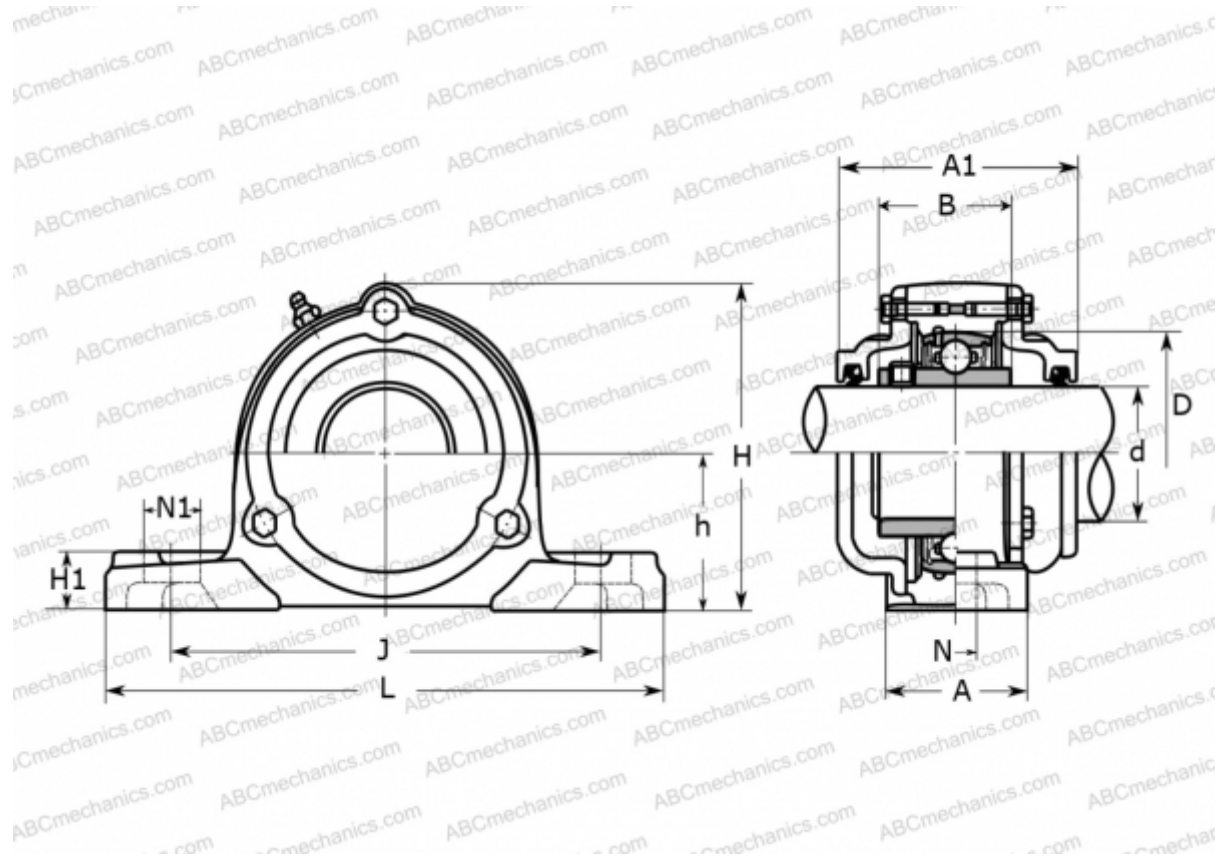

### Technical specification

#### DIMENSIONS, MM

d	45,000
D	85,000
B	49,200
L	190,000
H	114,000
A	54,000
J	146,000
A1	90,000
H1	20,000
N	17,000
N1	22,000
h	54,000

#### WEIGHT, KG

3,400

Bearing

UC 209

Housing

CP 209

#### MANUFACTURER

[ASAHI](http://www.asahi.com)