

CUCP 212C ASAHI

Ball bearing units

TYPE: Housing units, Plummer block, Cast iron housing, Radial insert ball bearing with grub screws in inner ring, Type CUCP..C with cast iron covers, open cover (ASAHI)

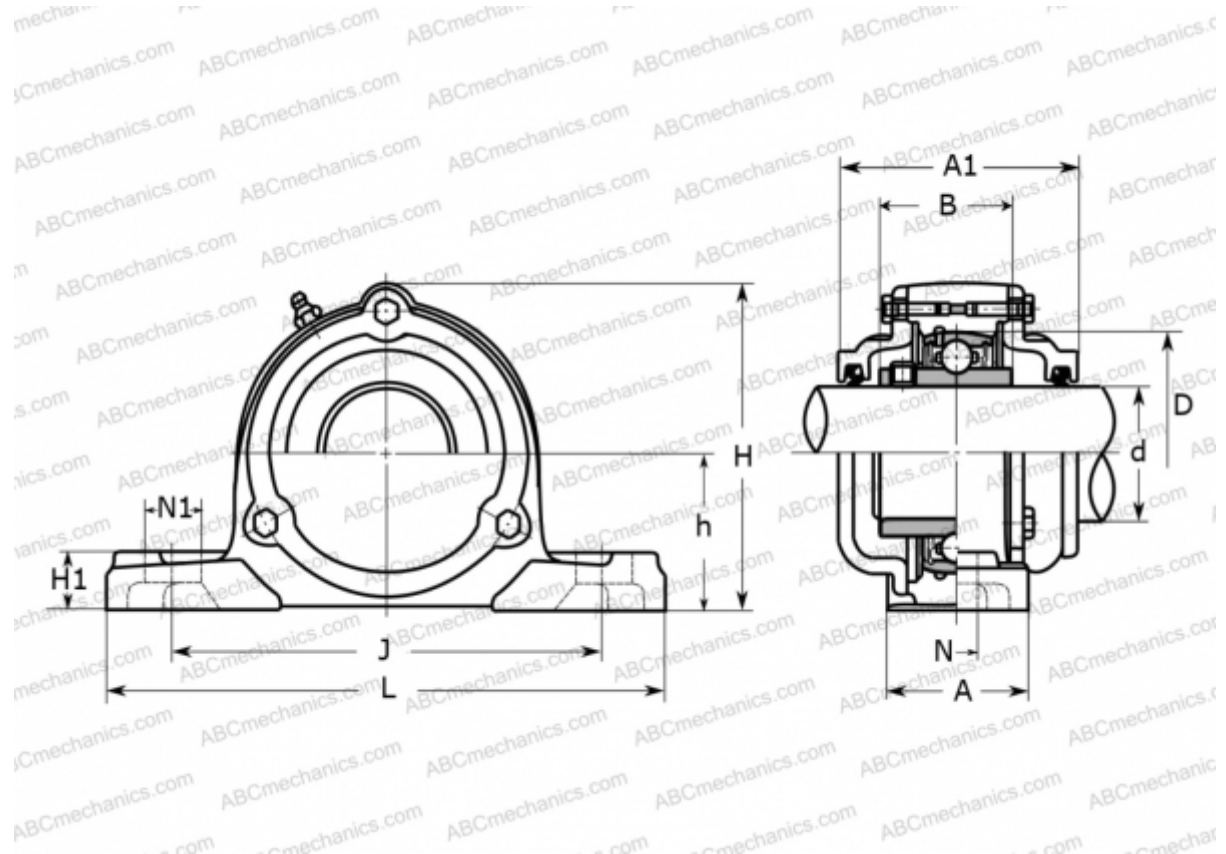

Technical specification

DIMENSIONS, MM

d	60,000
D	110,000
B	65,100
L	241,000
H	145,000
A	70,000
J	184,000
A1	114,000
H1	25,000
N	20,000
N1	25,000
h	69,000

WEIGHT, KG

6,700

Bearing	UC 212
Housing	CP 212

MANUFACTURER

[ASAHI](http://www.asahi.com)