

## CUCP 215C ASAHI

Ball bearing units

TYPE: Housing units, Plummer block, Cast iron housing, Radial insert ball bearing with grub screws in inner ring, Type CUCP..C with cast iron covers, open cover (ASAHI)

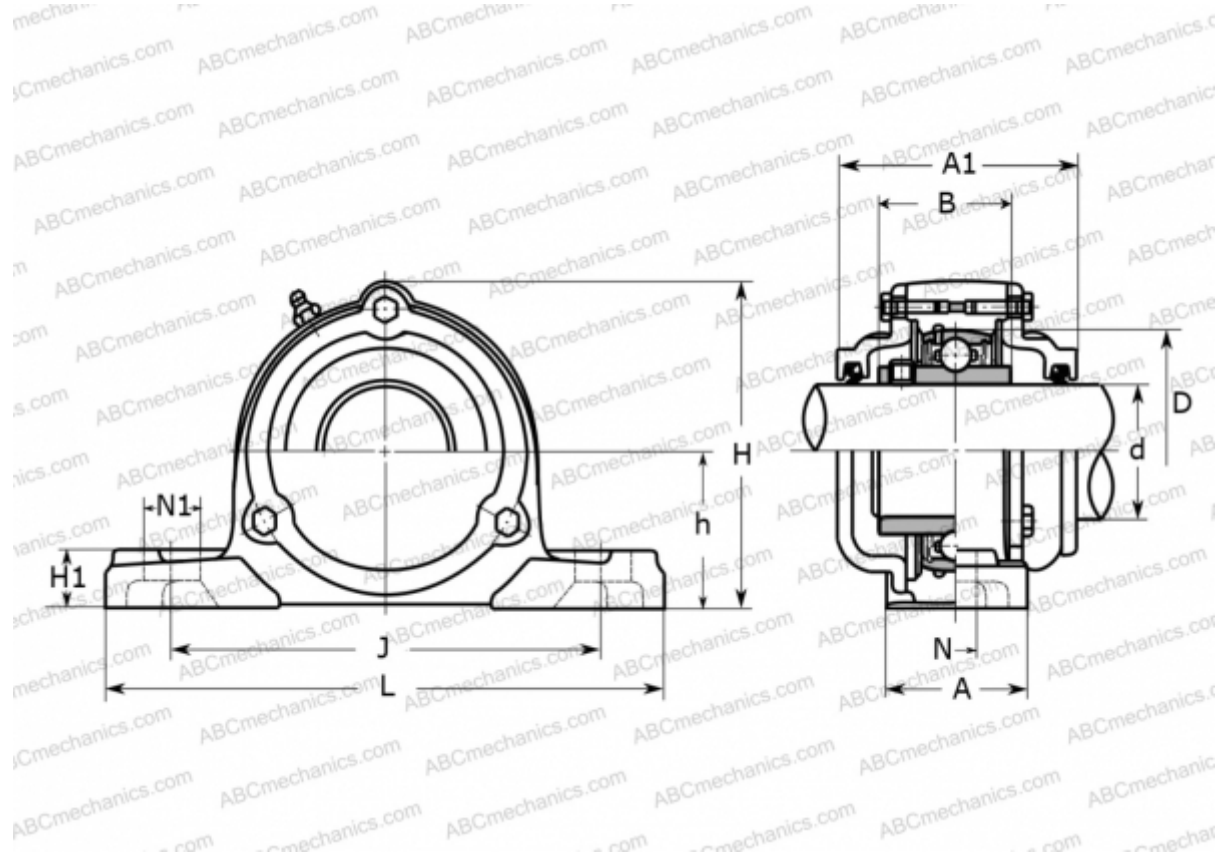

### Technical specification

#### DIMENSIONS, MM

d	75,000
D	130,000
B	77,800
L	275,000
H	167,000
A	74,000
J	217,000
A1	136,000
H1	28,000
N	25,000
N1	31,000
h	82,600

#### WEIGHT, KG

9,600

Bearing

UC 215

Housing

CP 215

#### MANUFACTURER

[ASAHI](http://www.asahi.com)