

## CUCP 207CE ASAHI

Ball bearing units

TYPE: Housing units, Plummer block, Cast iron housing, Radial insert ball bearing with grub screws in inner ring, Type CUCP..CE with cast iron covers, closed cover (ASAHI)

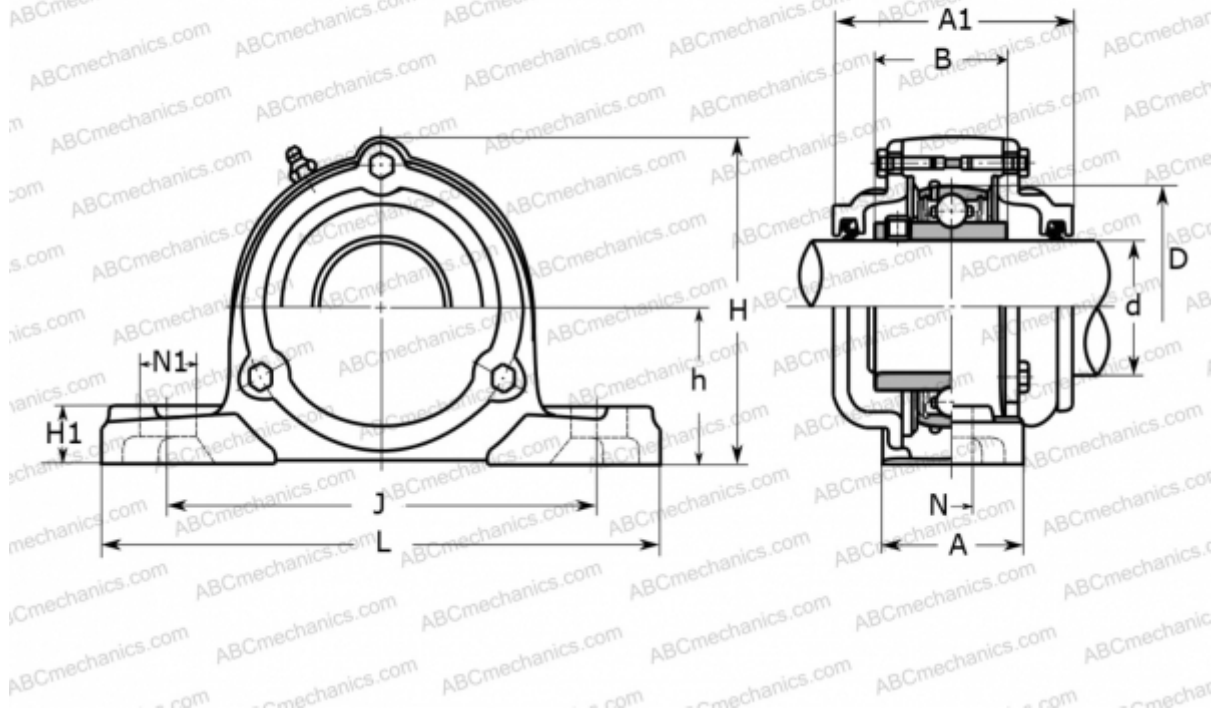

### Technical specification

#### DIMENSIONS, MM

d	35,000
D	72,000
B	42,900
L	167,000
H	97,000
A	48,000
J	127,000
A1	80,000
H1	19,000
N	17,000
N1	21,000
h	47,600

#### WEIGHT, KG

2,500

Bearing

UC 207

Housing

CP 207

#### MANUFACTURER

[ASAHI](http://www.asahi.com)