

CUCP 210CE ASAHI

Ball bearing units

TYPE: Housing units, Plummer block, Cast iron housing, Radial insert ball bearing with grub screws in inner ring, Type CUCP..CE with cast iron covers, closed cover (ASAHI)

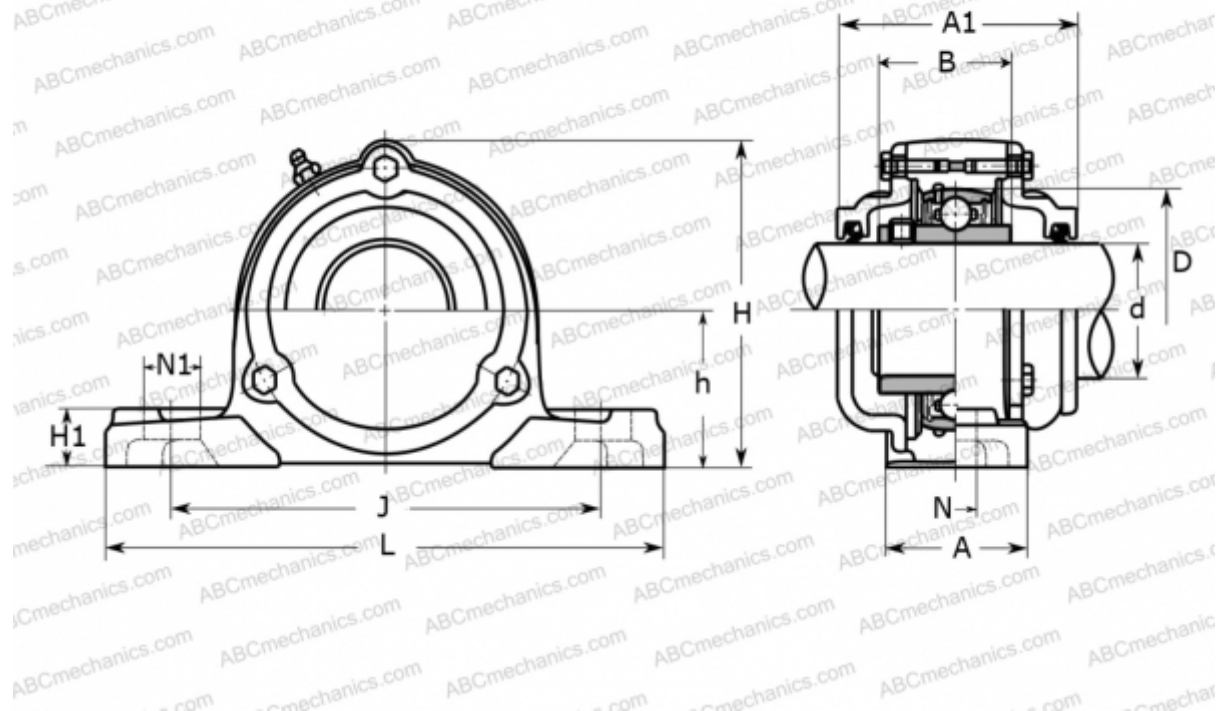

Technical specification

DIMENSIONS, MM

d	50,000
D	90,000
B	51,600
L	206,000
H	120,000
A	60,000
J	159,000
A1	98,000
H1	22,000
N	20,000
N1	25,000
h	57,200

WEIGHT, KG

4,100

Bearing

UC 210

Housing

CP 210

MANUFACTURER

[ASAHI](http://www.asahi.com)