

CUCP 214CE ASAHI

Ball bearing units

TYPE: Housing units, Plummer block, Cast iron housing, Radial insert ball bearing with grub screws in inner ring, Type CUCP..CE with cast iron covers, closed cover (ASAHI)

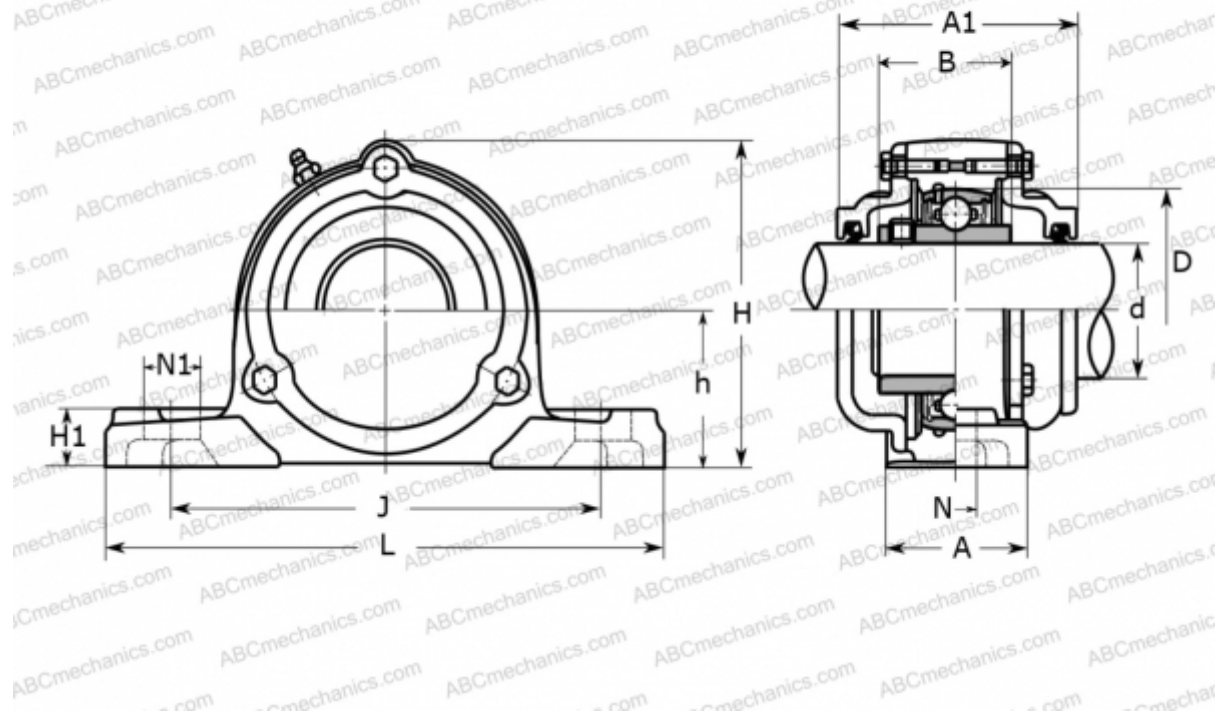

Technical specification

DIMENSIONS, MM

d	70,000
D	125,000
B	74,600
L	266,000
H	162,000
A	72,000
J	210,000
A1	134,000
H1	27,000
N	25,000
N1	31,000
h	79,400

WEIGHT, KG

9,300

Bearing	UC 214
Housing	CP 214

MANUFACTURER

[ASAHI](http://www.asahi.com)