

CUCP 216CE ASAHI

Ball bearing units

TYPE: Housing units, Plummer block, Cast iron housing, Radial insert ball bearing with grub screws in inner ring, Type CUCP..CE with cast iron covers, closed cover (ASAHI)

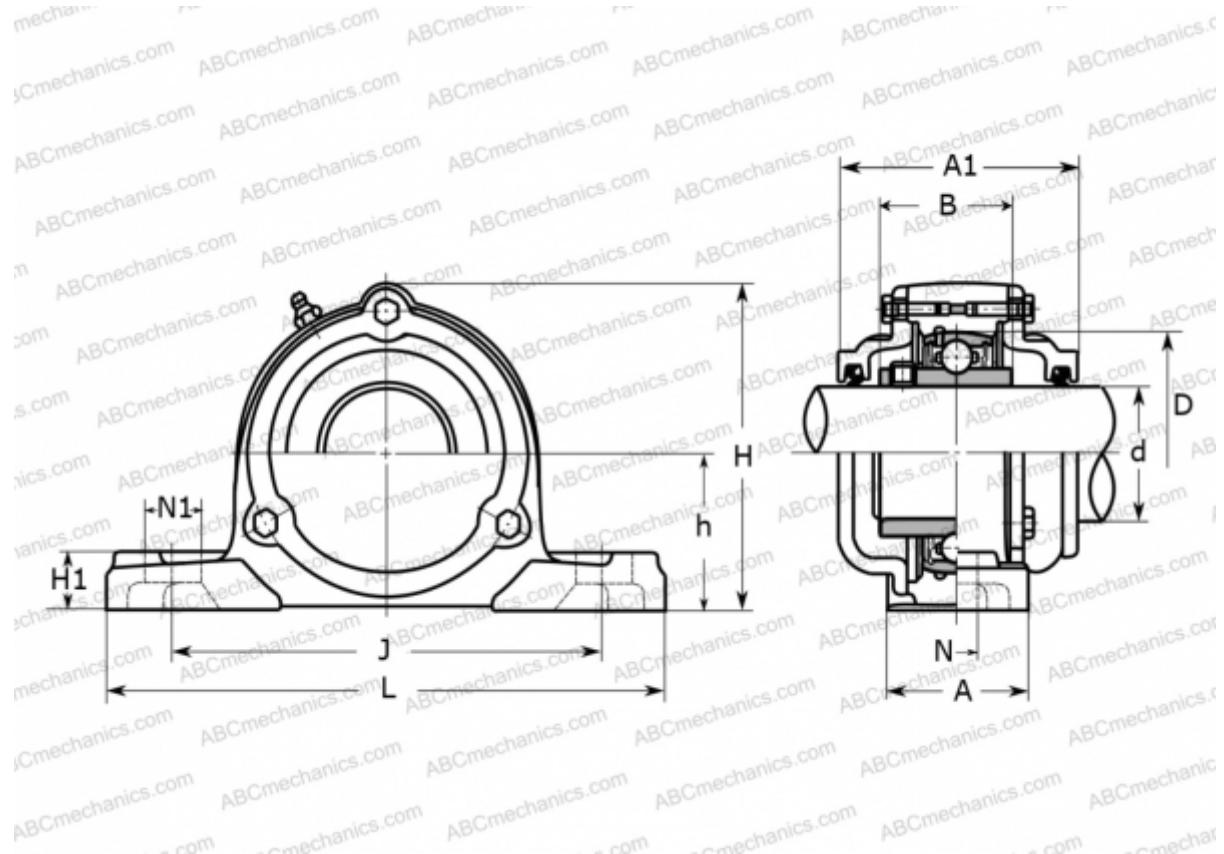

Technical specification

DIMENSIONS, MM

d	80,000
D	140,000
B	82,600
L	292,000
H	188,000
A	78,000
J	232,000
A1	146,000
H1	30,000
N	25,000
N1	31,000
h	88,900

WEIGHT, KG

12,200

Bearing	UC 216
Housing	CP 216

MANUFACTURER

[ASAHI](http://www.asahi.com)