

CUCP 217CE ASAHI

Ball bearing units

TYPE: Housing units, Plummer block, Cast iron housing, Radial insert ball bearing with grub screws in inner ring, Type CUCP..CE with cast iron covers, closed cover (ASAHI)

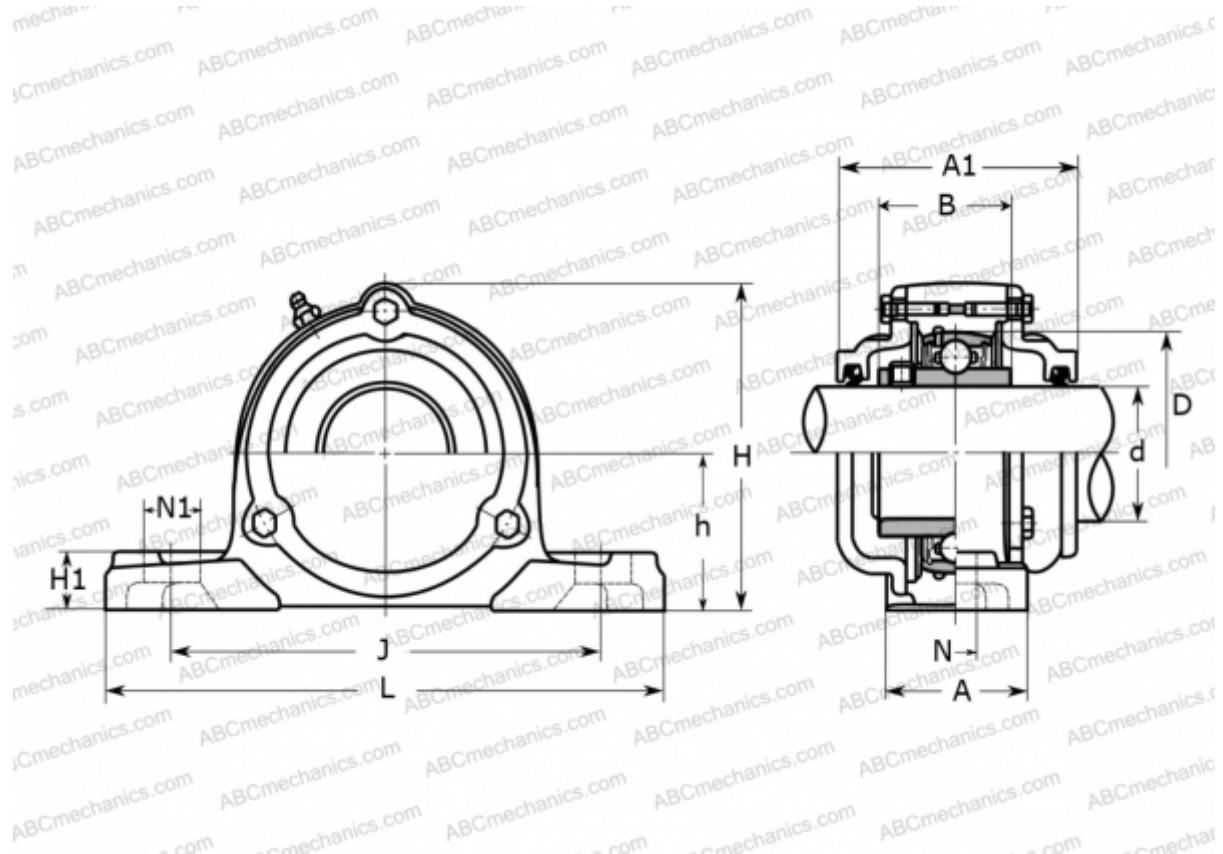

Technical specification

DIMENSIONS, MM

d	85,000
D	150,000
B	85,700
L	310,000
H	199,000
A	83,000
J	247,000
A1	150,000
H1	32,000
N	25,000
N1	31,000
h	95,200

WEIGHT, KG

14,200

Bearing	UC 217
Housing	CP 217

MANUFACTURER

[ASAHI](http://www.asahi.com)