

UCP 202C ASAHI

Ball bearing units

TYPE: Housing units, Plummer block, Cast iron housing, Radial insert ball bearing with grub screws in inner ring, Type UCP..C with pressed steel covers, open cover (ASAHI)

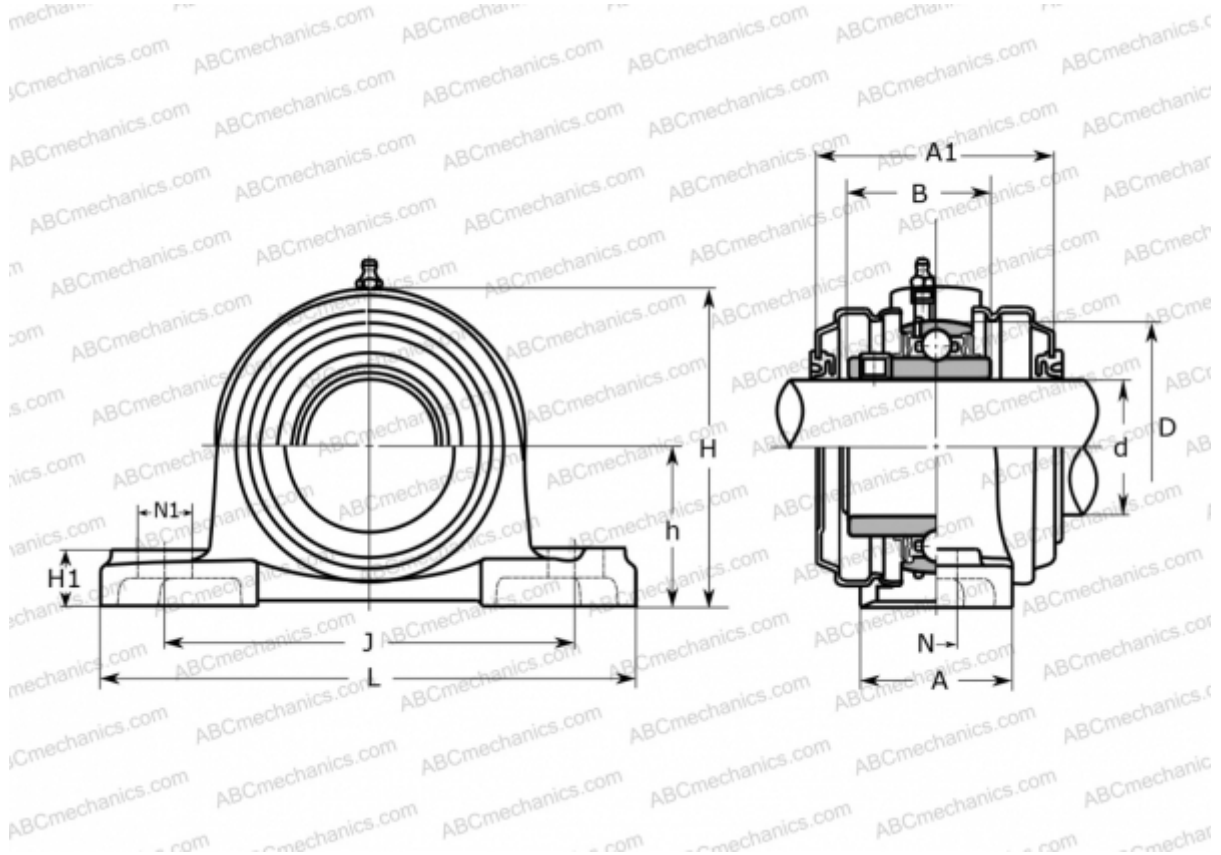

Technical specification

DIMENSIONS, MM

d	15,000
D	47,000
B	31,000
L	127,000
H	62,000
A	38,000
J	95,000
A1	56,000
H1	15,000
N	13,000
N1	19,000
h	30,200

WEIGHT, KG

0,690

Bearing

UC 202

Housing

P 203C

MANUFACTURER

[ASAHI](http://www.asahi.com)