

## UCP 204C ASAHI

Ball bearing units

TYPE: Housing units, Plummer block, Cast iron housing, Radial insert ball bearing with grub screws in inner ring, Type UCP..C with pressed steel covers, open cover (ASAHI)

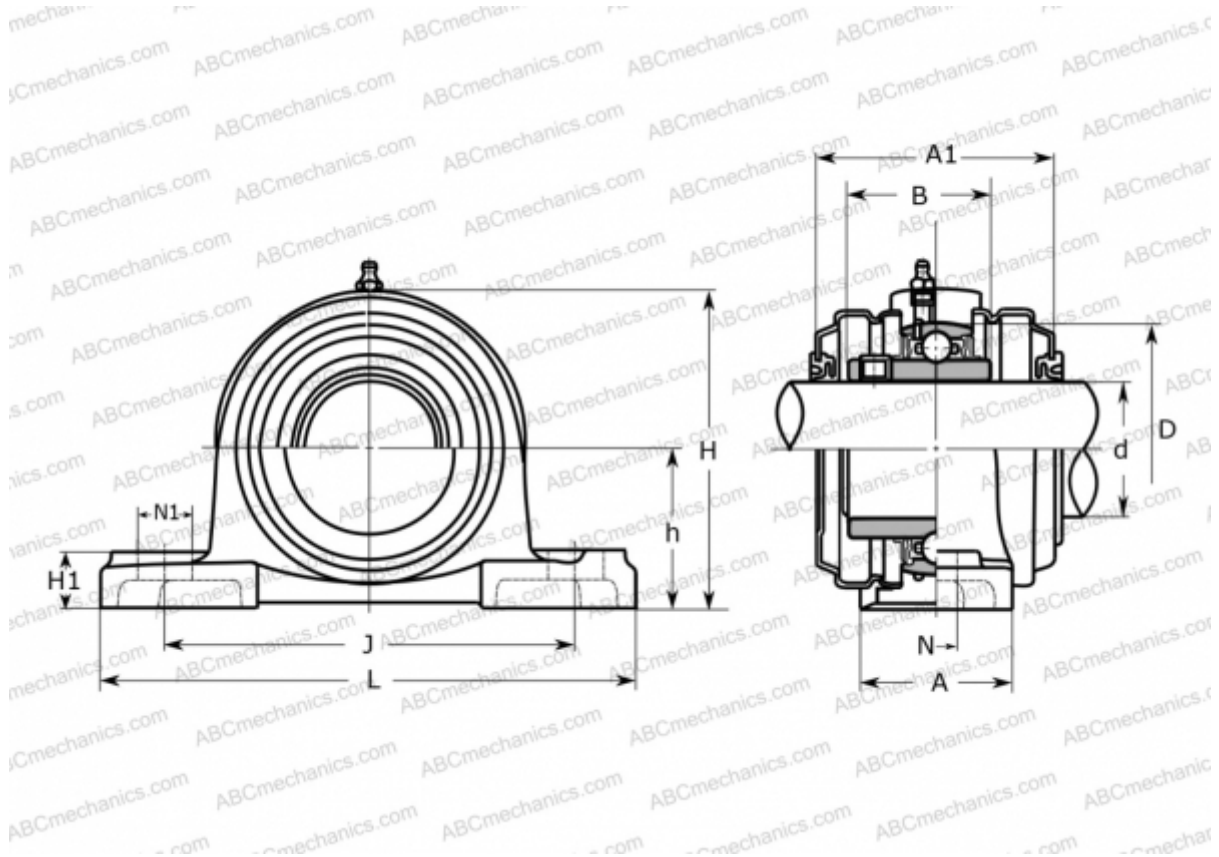

### Technical specification

#### DIMENSIONS, MM

d	20,000
D	47,000
B	31,000
L	127,000
H	65,000
A	38,000
J	95,000
A1	56,000
H1	15,000
N	13,000
N1	19,000
h	33,300

#### WEIGHT, KG

0,710

Bearing

UC 204

Housing

P 204C

#### MANUFACTURER

[ASAHI](http://www.asahi.com)