

UCP 207C ASAHI

Ball bearing units

TYPE: Housing units, Plummer block, Cast iron housing, Radial insert ball bearing with grub screws in inner ring, Type UCP..C with pressed steel covers, open cover (ASAHI)

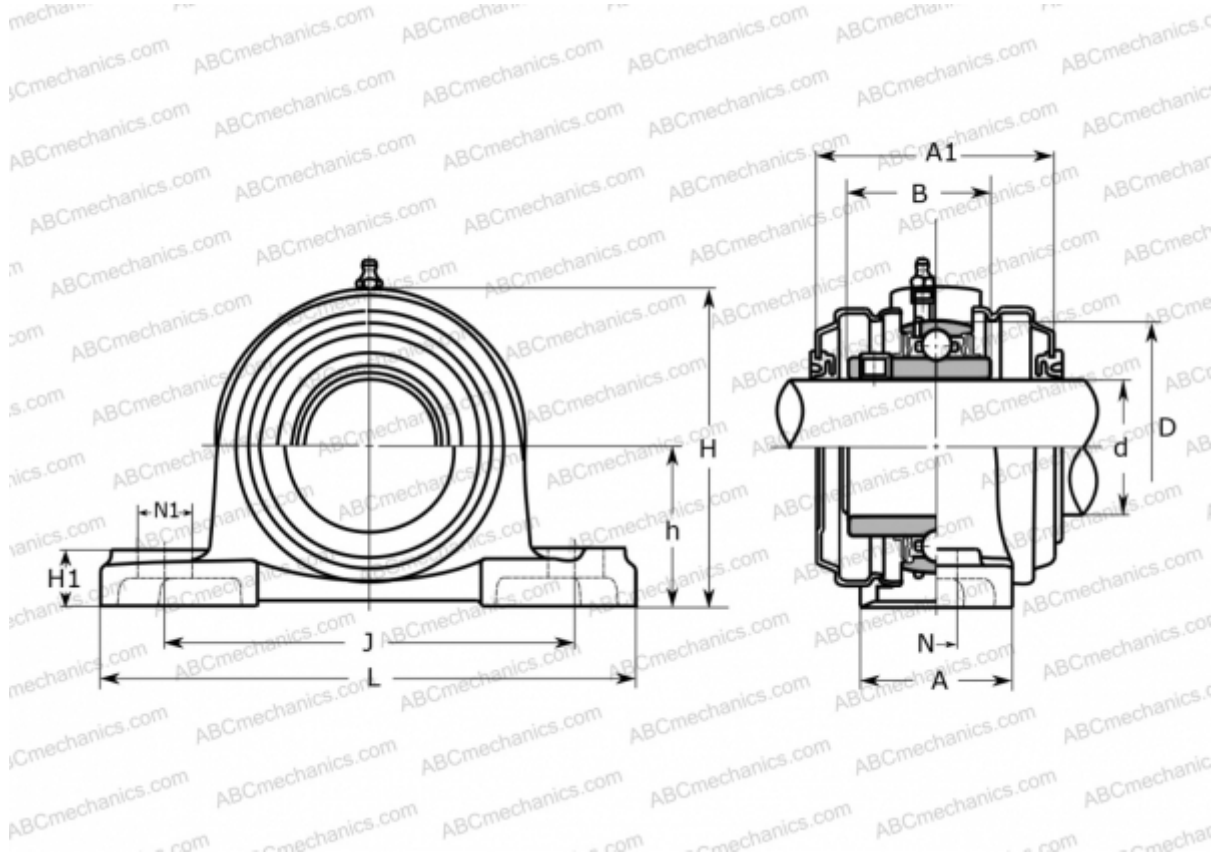

Technical specification

DIMENSIONS, MM

d	35,000
D	72,000
B	42,900
L	167,000
H	94,000
A	48,000
J	127,000
A1	70,000
H1	19,000
N	17,000
N1	21,000
h	47,600

WEIGHT, KG

1,700

Bearing

UC 207

Housing

P 207C

MANUFACTURER

[ASAHI](http://www.asahi.com)