

## UCP 209C ASAHI

Ball bearing units

TYPE: Housing units, Plummer block, Cast iron housing, Radial insert ball bearing with grub screws in inner ring, Type UCP..C with pressed steel covers, open cover (ASAHI)

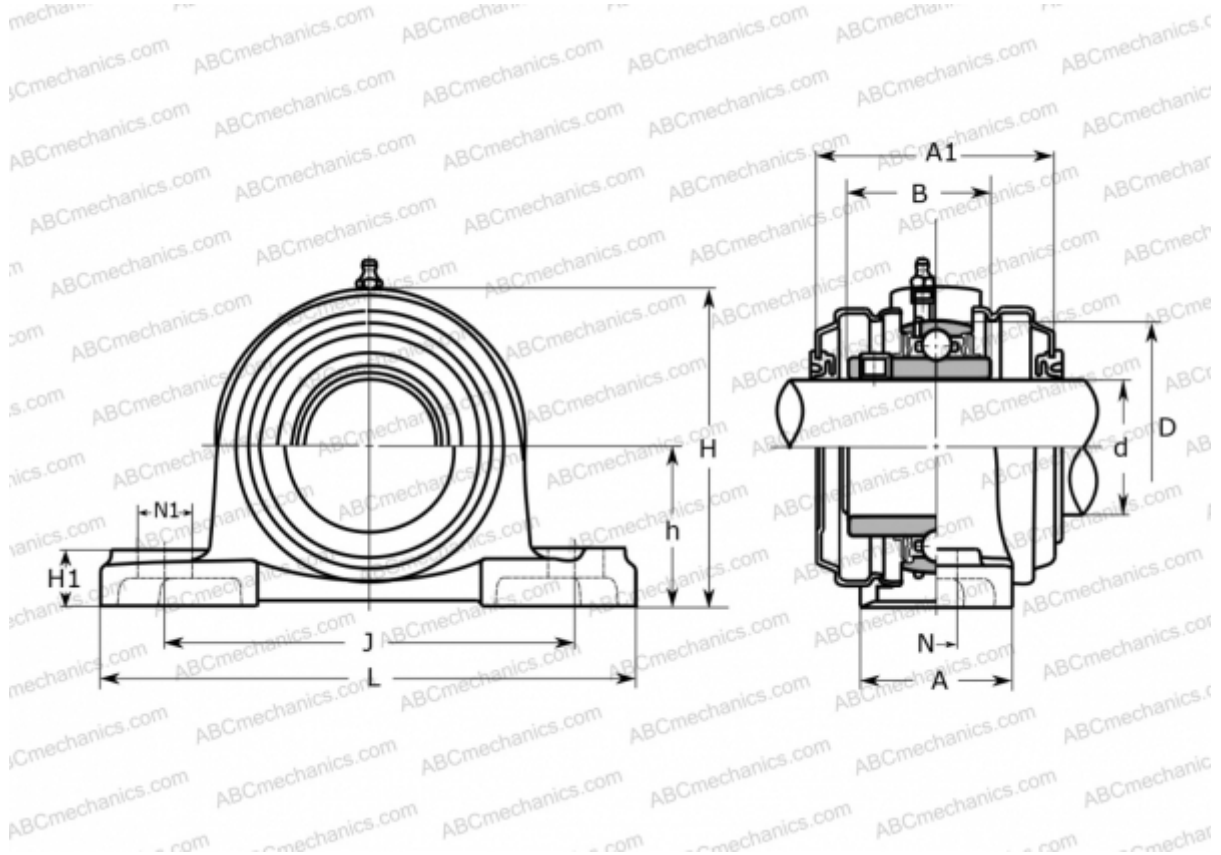

### Technical specification

#### DIMENSIONS, MM

d	45,000
D	85,000
B	49,200
L	190,000
H	108,000
A	54,000
J	146,000
A1	82,000
H1	20,000
N	17,000
N1	22,000
h	54,000

#### WEIGHT, KG

2,500

Bearing

UC 209

Housing

P 209C

#### MANUFACTURER

[ASAHI](http://www.asahi.com)