

## UCP 213C ASAHI

Ball bearing units

TYPE: Housing units, Plummer block, Cast iron housing, Radial insert ball bearing with grub screws in inner ring, Type UCP..C with pressed steel covers, open cover (ASAHI)

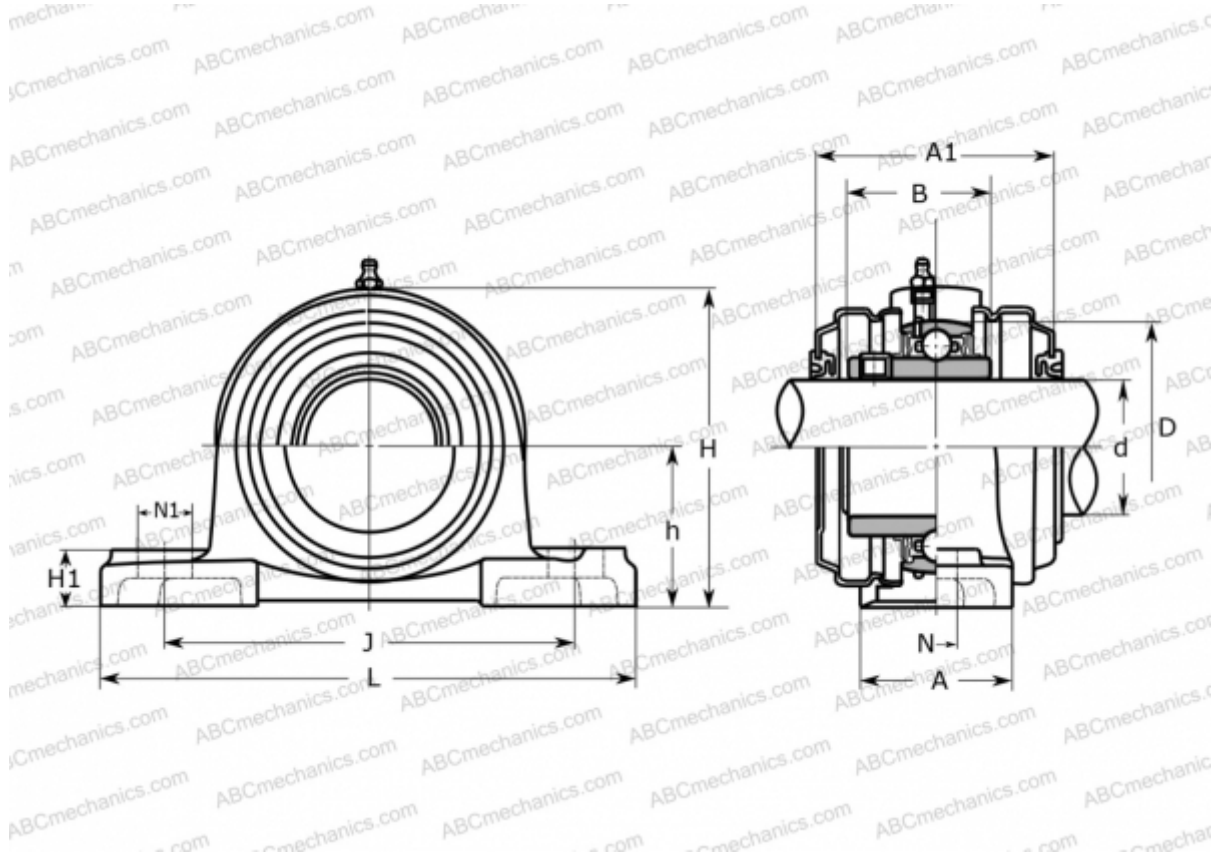

### Technical specification

#### DIMENSIONS, MM

d	65,000
D	120,000
B	65,100
L	265,000
H	150,000
A	70,000
J	203,000
A1	102,000
H1	27,000
N	25,000
N1	29,000
h	76,200

#### WEIGHT, KG

6,100

Bearing

UC 213

Housing

P 213C

#### MANUFACTURER

[ASAHI](http://www.asahi.com)