

UCP 208E ASAHI

Ball bearing units

TYPE: Housing units, Plummer block, Cast iron housing, Radial insert ball bearing with grub screws in inner ring, Type UCP..E with pressed steel covers, closed cover (ASAHI)

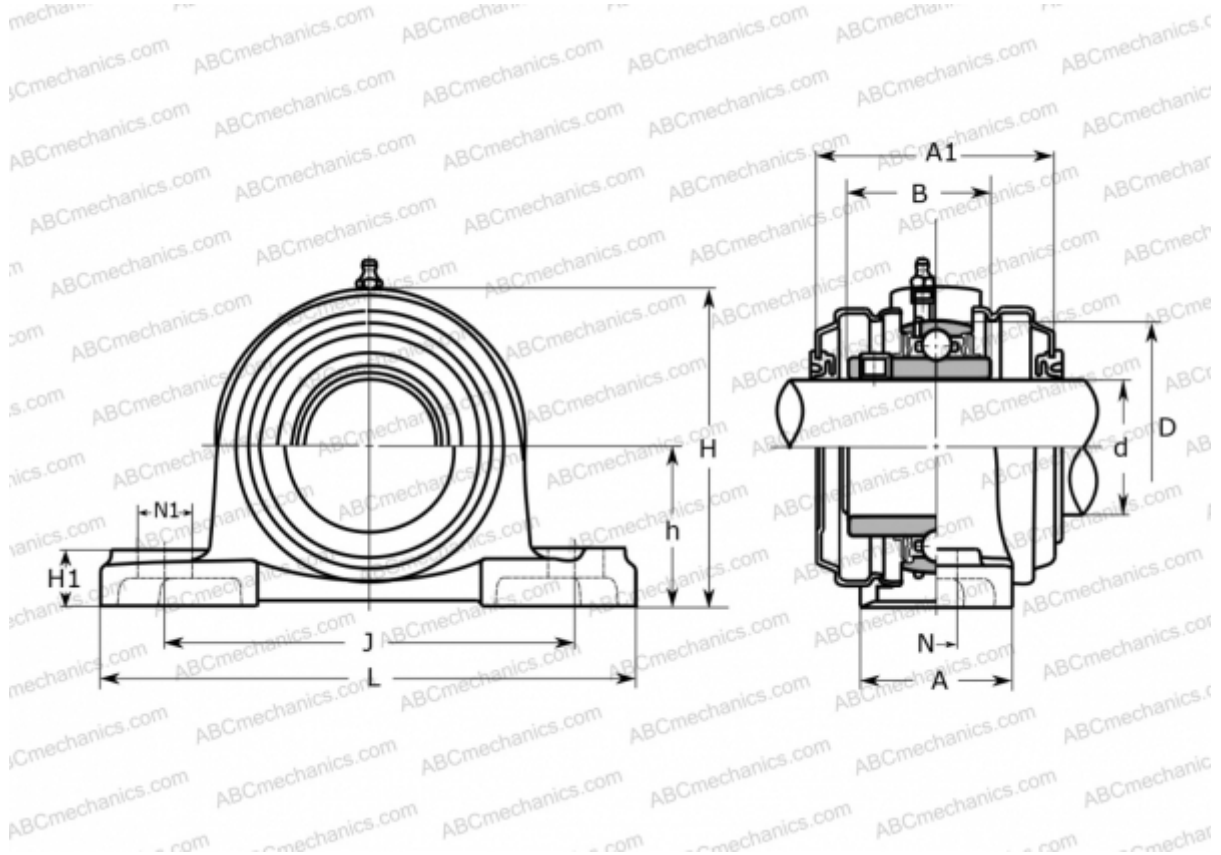

Technical specification

DIMENSIONS, MM

d	40,000
D	80,000
B	49,200
L	184,000
H	100,000
A	54,000
J	137,000
A1	82,000
H1	19,000
N	17,000
N1	25,000
h	49,200

WEIGHT, KG

2,200

Bearing

UC 208

Housing

P 208C

MANUFACTURER

[ASAHI](http://www.asahi.com)