

UCP 211E ASAHI

Ball bearing units

TYPE: Housing units, Plummer block, Cast iron housing, Radial insert ball bearing with grub screws in inner ring, Type UCP..E with pressed steel covers, closed cover (ASAHI)

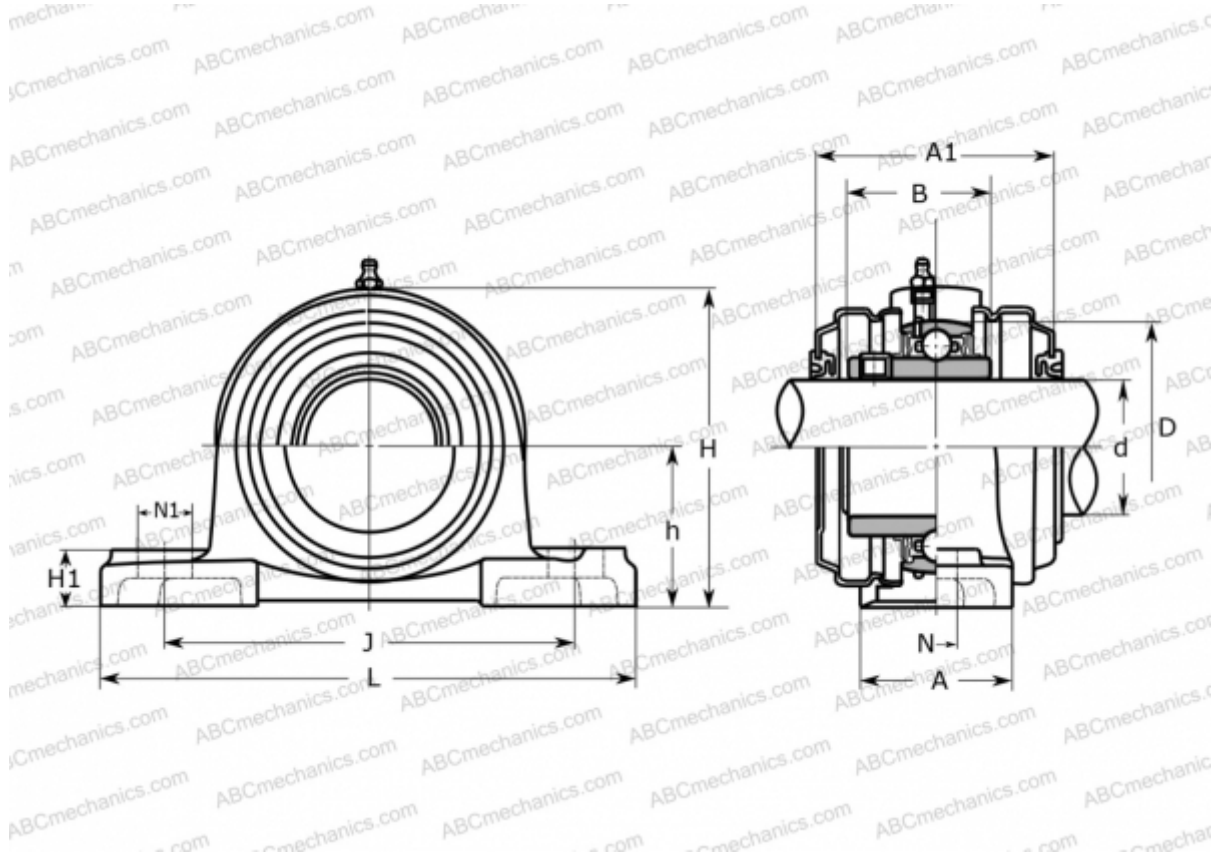

Technical specification

DIMENSIONS, MM

d	55,000
D	100,000
B	55,600
L	219,000
H	126,000
A	60,000
J	171,000
A1	88,000
H1	22,000
N	20,000
N1	25,000
h	63,500

WEIGHT, KG

3,700

Bearing

UC 211

Housing

P 211C

MANUFACTURER

[ASAHI](#)