

UCP 213E ASAHI

Ball bearing units

TYPE: Housing units, Plummer block, Cast iron housing, Radial insert ball bearing with grub screws in inner ring, Type UCP..E with pressed steel covers, closed cover (ASAHI)

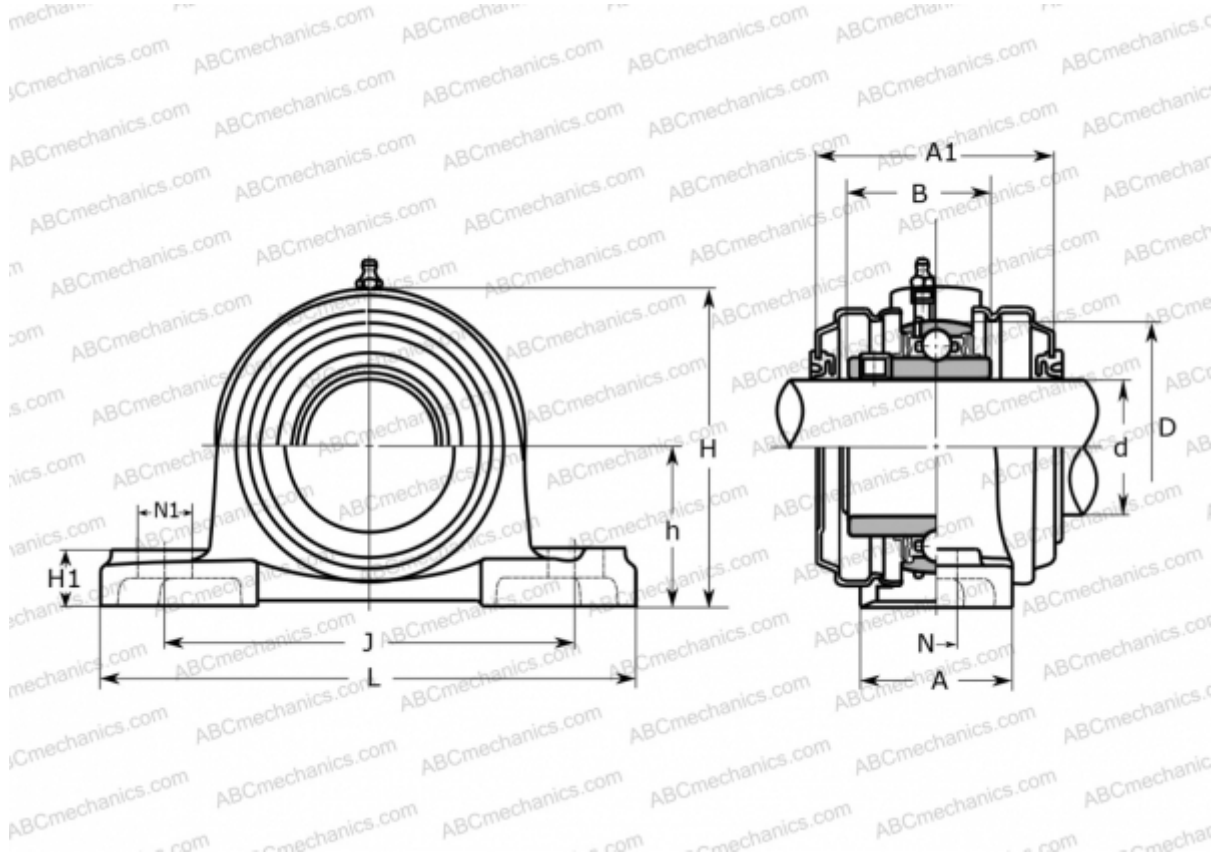

Technical specification

DIMENSIONS, MM

d	65,000
D	120,000
B	65,100
L	265,000
H	150,000
A	70,000
J	203,000
A1	102,000
H1	27,000
N	25,000
N1	29,000
h	76,200

WEIGHT, KG

6,100

Bearing

UC 213

Housing

P 213C

MANUFACTURER

[ASAHI](http://www.asahi.com)