

## UCIP 208 ASAHI

Ball bearing units

TYPE: Housing units, Plummer block, Cast iron housing, Radial insert ball bearing with grub screws in inner ring, Type UCIP (ASAHI)

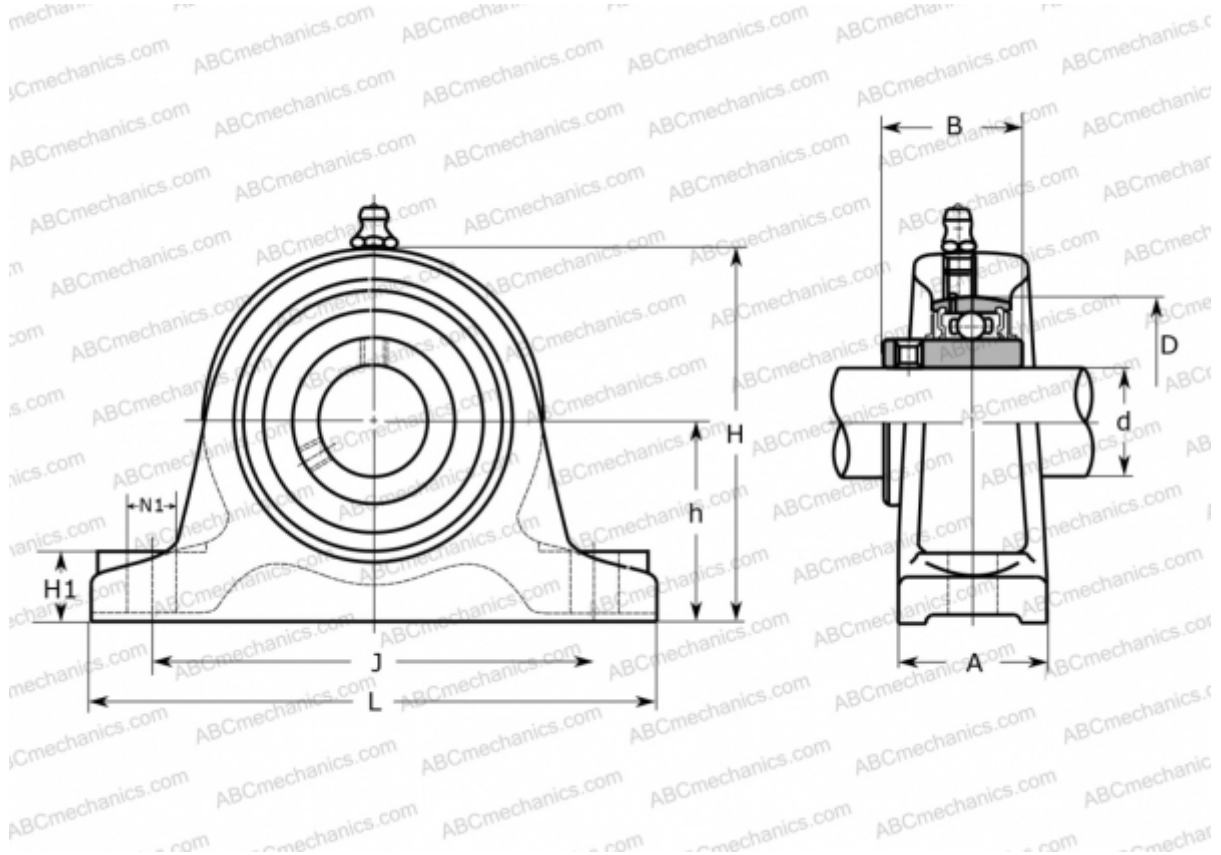

### Technical specification

#### DIMENSIONS, MM

d	40,000
D	80,000
B	49,200
L	200,000
H	115,000
A	60,000
J	150,000
H1	25,000
N1	19,000
h	60,000

#### MANUFACTURER

[ASAHI](#)

#### WEIGHT, KG

3,600

Bearing	UC 208
Housing	IP 208