

UCIP 209 ASAHI

Ball bearing units

TYPE: Housing units, Plummer block, Cast iron housing, Radial insert ball bearing with grub screws in inner ring, Type UCIP (ASAHI)

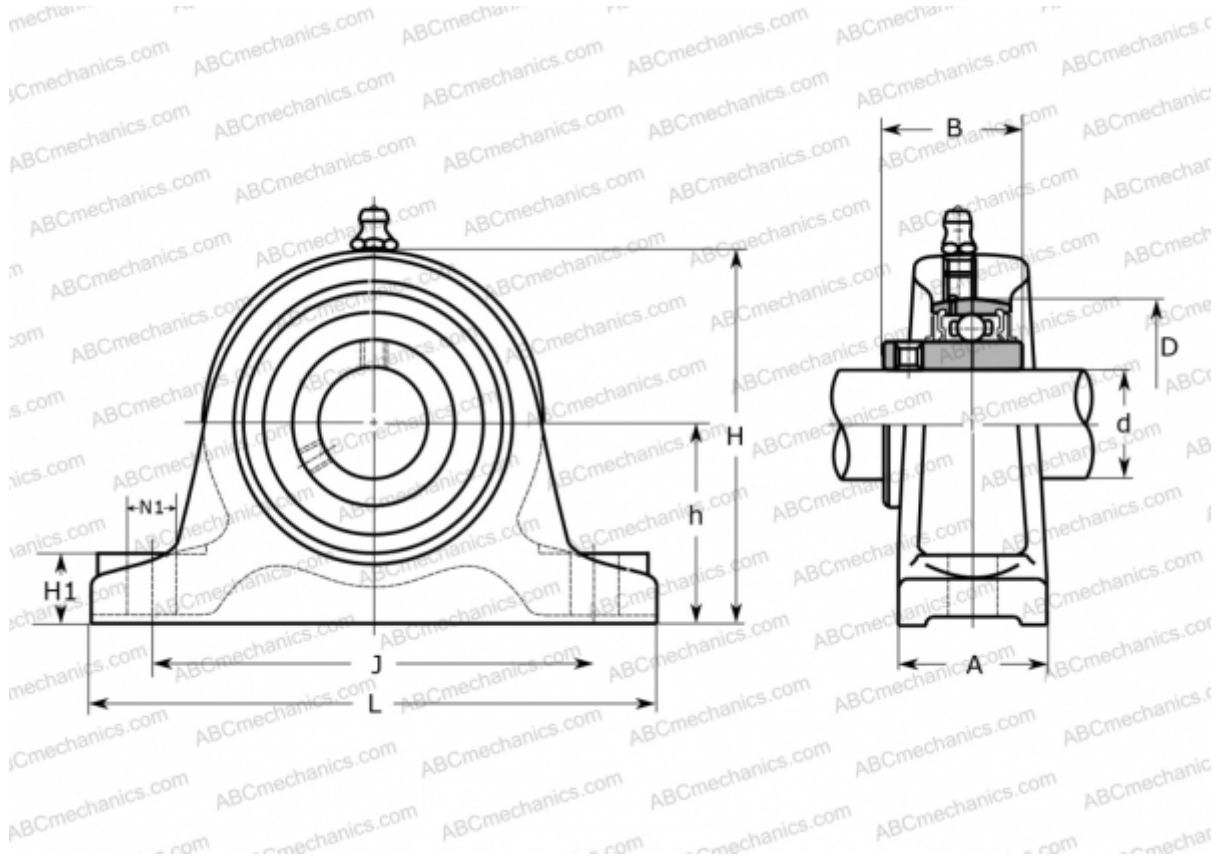

Technical specification

DIMENSIONS, MM

d	45,000
D	85,000
B	49,200
L	210,000
H	128,000
A	60,000
J	160,000
H1	25,000
N1	19,000
h	70,000

MANUFACTURER

[ASAHI](#)

WEIGHT, KG

3,800

Bearing	UC 209
Housing	IP 209