

UCIP 210 ASAHI

Ball bearing units

TYPE: Housing units, Plummer block, Cast iron housing, Radial insert ball bearing with grub screws in inner ring, Type UCIP (ASAHI)

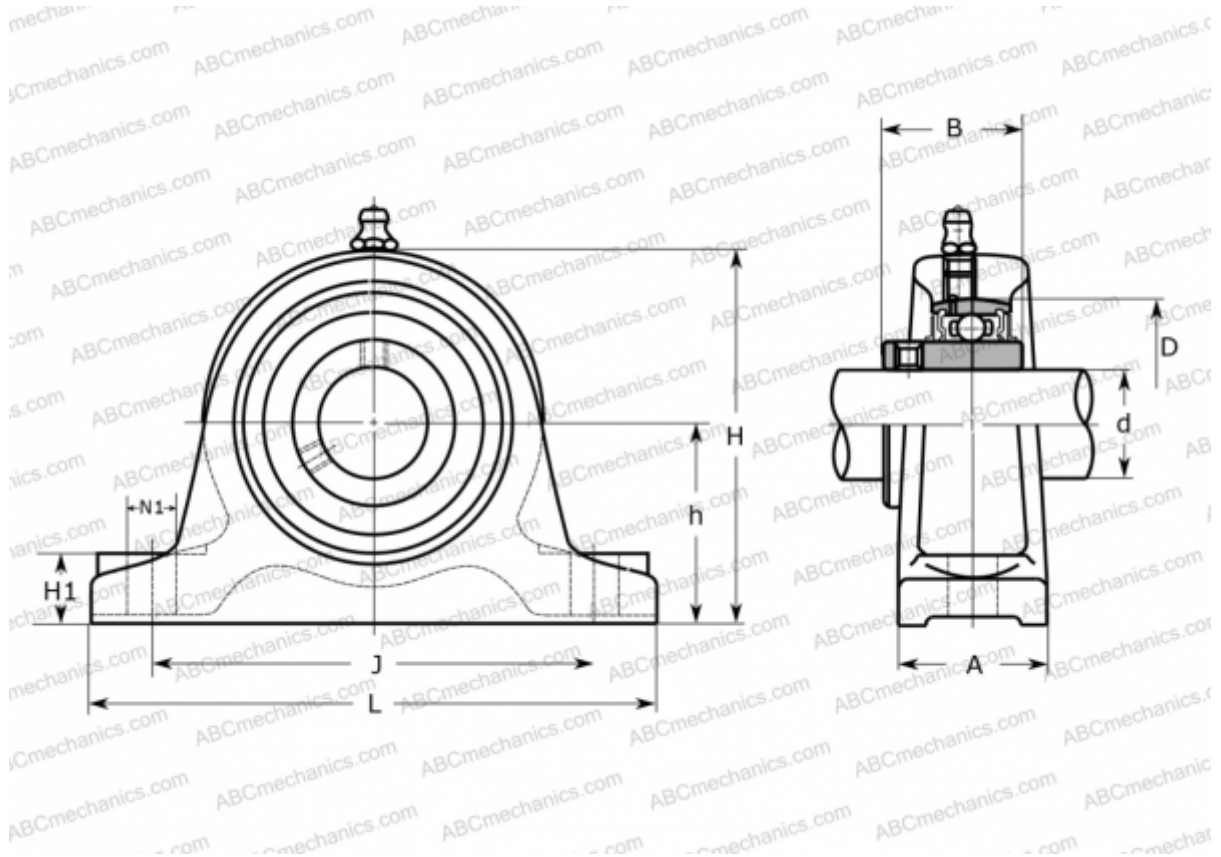

Technical specification

DIMENSIONS, MM

d	50,000
D	90,000
B	51,600
L	220,000
H	132,000
A	60,000
J	170,000
H1	28,000
N1	19,000
h	70,000

MANUFACTURER

[ASAHI](#)

WEIGHT, KG

4,400

Bearing	UC 210
Housing	IP 210